

Support arm pivot

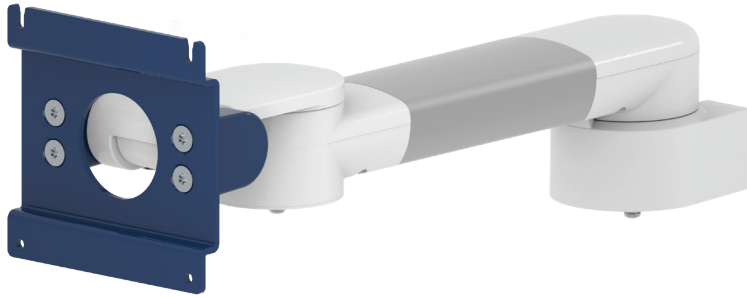

Monitor adaption

Colours to choose

Max. load capacity support arm

Max. load monitor adaption

Product weight

Part number

Elo Touch adaption

decorative parts RAL 5013 cobalt blue / RAL 7024 graphite grey
 aluminum parts RAL 9016 traffic white / RAL 9002 grey white

18 kg / 39.7 lbs

18 kg / 39.7 lbs

240 mm / 9.5": 1.9 kg / 4.2 lbs 300 mm / 11.8": 2 kg / 4.4 lbs

arm length 240 mm / 9.5"

A-224G5-Y.CD

arm length 300 mm / 11.8"

A-230G5-Y.CD

Fixings

Y



4V

Adapter for vertical wall channel



2F

Fixed rail clamp

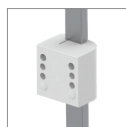

3

Vertical rail clamp

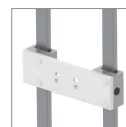

3DR
3TX

Dual vertical rail clamp



1
1F
1C
1V

Fixed / universal pole clamp



13

Adapter for Mindray medical supply units



17

Adapter for Amico pendants & headwalls



10

Adapter for Maquet anaesthesia machines

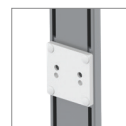

9

Adapter for Löwenstein Medical anaesthesia machines



4K

Adapter for anaesthesia machines with existing side channel

Support arm pivot

Technical data - arm length 300 mm / 11.8"

SIDE VIEW

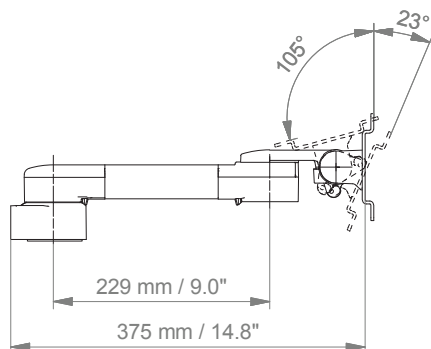

TOP VIEW

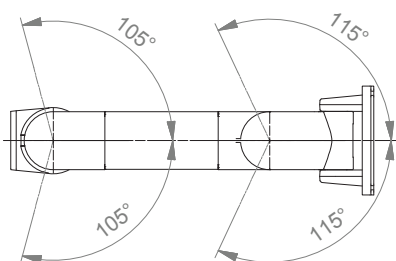

Fixings

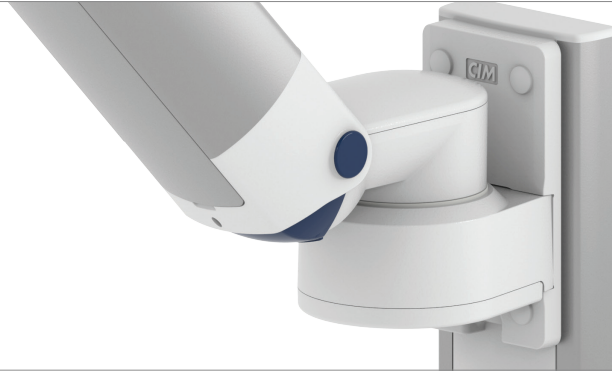









Illustration	Description	Notes	Part no.
	Adapter for vertical wall channel	To mount to CIM wall channel (compatible with GCX channel) For arms with high mounting positions Please order separately: CIM wall channel, see catalogue accessoires	4V 4U
	Fixed rail clamp	To mount to horizontal European rails 10 x 25, 8 x 35, 10 x 30, 10 x 50 mm	2F
	Vertical rail clamp	To mount to vertical European rail 10 x 25 mm	3
	Dual vertical rail clamp	To mount to two parallel vertical European rails 10 x 50 mm Distance between rails 150 mm / 5.9", e.g. Dräger pendant Distance between rails 225 mm / 8.9", e.g. Trilux pendant	3DR 3TX
	Fixed pole clamp	To mount to pole \varnothing 25 mm / 1.0" To mount to pole \varnothing 35 mm / 1.4" To mount to pole \varnothing 38 mm / 1.5"	1 1F 1C
	Universal pole clamp	V-block to mount to pole \varnothing 23 - 40 mm / 0.9 - 1.6"	1V
	Adapter medical supply units	For Mindray medical supply units	13
	Adapter pendants & headwalls	For Amico pendants & headwalls	17

Fixings for anaesthesia machines

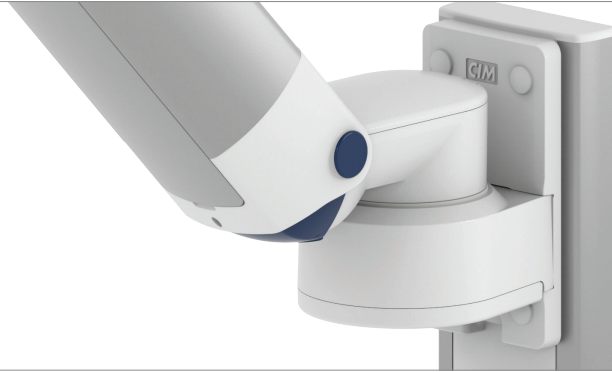

Illustration	Description	Notes	Part no.
	Adapter for Löwenstein Medical anaesthesia machines	Adapter for Leon / Leon plus	9
	Adapter for anaesthesia machines (all suppliers)	H 80 mm / 3.1" With existing side channel	4K
If your anaesthesia machine does not have a side channel already mounted to the machine, please order the following in addition to 4K:			
	Adapter for Dräger	Dräger Primus / Julian / Cato / Fabius GS / Zeus side channel adapter L 127 mm / 5" side channel adapter L 320 mm / 12.6"	DR-J01 DR-J02
			
	Adapter for GE	GE Avance / Aespire / Aestiva side channel adapter L 200 mm / 7.9"	DX-AES-01
			

How to create part numbers

Part numbers can be easily created by following the steps below:

Please replace the letters in **green** with the part no. code as per your requirements.

1. Components' grounding:

S	=	not grounded
A	=	grounded

2. Choose the arm version required:

910G5	=	flush mount
224G5 / 230G5	=	support arm pivot
33030G5	=	extended pivot arm light duty
431G5	=	height adjustable arm
73130G5	=	extended height adjustable arm
531G5	=	high position height adjustable arm
83130G5	=	extended high position height adjustable arm

3. Specify where you want to mount the arm and select the fixing (Y):

1V	=	pole ø 23 - 40 mm / 0.9 - 1.6"
1	=	pole ø 25 mm / 1.0"
1F	=	pole ø 35 mm / 1.4"
1C	=	pole ø 38 mm / 1.5"
2F	=	horizontal rails 10 x 25, 8 x 35, 10 x 30, 10 x 50 mm
3	=	vertical rail 10 x 25 mm
3DR	=	dual vertical rails, distance 150 mm/ 5.9"
3TX	=	dual vertical rails, distance 225 mm/ 8.9"
4V	=	vertical wall channel
4U	=	vertical wall channel for arms with high mounting position
13	=	Mindray medical supply units
17	=	Amico pendants & headwalls
9	=	Löwenstein Medical anaesthesia machine
4K	=	anaesthesia machine with existing channel

How to create part numbers

4. Choose the colour requested for decorative parts (C):

- gr = RAL 7024 (dark grey)
- bl = RAL 5013 (blue)

5. Choose the colour requested for the aluminium die-cast parts (D):

- 1 = RAL 9016 (pure white)
- 2 = RAL 9002 (grey white)

6. Specify the spring depending on the weight of your monitor/ device - only with height adjustable arms (X):

- 95 = 4 - 9 kg / 8.8 - 19.8 lbs

Example

01 Grounding		02 Arm version		03 Fixing		04 & 05 Colour		06 Spring tension
A	-	431G5	-	Y	.	CD	-	X
A	-	431G5	-	4V	.	gr1	-	95

General notes

Monitor Adaptations

Back mounted adaptation for Mindray Elo Touch monitors.

Components' grounding

All arms with integrated cable management are equipped with **component grounding**. No grounding is required for arms with external or semi-integrated cable management with cables not being led through joints.

Load capacity

All **height adjustable arms** have a load capacity of 22 kg / 48.5 lbs. Rear mounted monitor adaptations and horizontally mounted 5" plunge plates accept a maximum monitor weight of 18 kg / 39.7 lbs. An additional 4 kg / 8.8 lbs may be mounted on a down post underneath the front swivel part. Depending on material and tensile factor all weight indications have a 4-fold and / or 6-fold safety factor according to EN 60601-1, 3rd Edition regulations.

Custom-designed solutions and MRI applications

Please contact us for **custom-designed** solutions.

Product marking

All CIM products are CE marked. As **medical product risk class 1** and they conform with the regulations MDD 93/42 ECC and EN 60601-1, 3rd Edition. TUEV reports for numerous products especially for anaesthesia applications guarantee electrical and mechanical safety of our products and are available upon request.

Product highlights

Non-height adjustable arm

Pivot and extended pivot arms offer **full cable integration** and easy cleaning for **infection control** in all critical care areas in the clinical environment. Our **5-years warranty** guarantees reliable, trouble-free and maintenance-free operation. The swivel function at the fixing point as well as the **tilt/ swivel function** of the monitor adaptation offers optimum positioning of your device. The extended pivot arm is a two-part arm with central pivot point between the two arm sections. All bottom-mounted monitors have the safety feature of a **20° tilt stop**.

Height adjustable arm

The height adjustable arm offers **full cable integration**, one-wipe clean surfaces and our **5-year warranty** on the entirety of the product. Vertically and horizontally adjustable, the arm offers optimal positioning of your device. A constant viewing angle when vertically adjusted is guaranteed by a parallel linkage. **Weight-optimized springs counter-balance** the monitor without making any adjustments. All bottom-mounted monitors have the safety feature of a **20° tilt stop**. Individual rotational stops may be integrated in any joint.

To provide the perfect combination of arm and monitor, the CIM articulated height adjustable arm has a simple quarter-turn lock to hold the arm safely in position when removing the monitor. Furthermore the arm is equipped with the unique safety feature of a slow-release gas spring. Should anybody try to remove the monitor before locking the arm in position, the arm will only rise at a slow and even tempo.

SAFETY