

Height adjustable arm with space-saving L-bracket



Monitor adaption	L-bracket VESA 75/100 and keyboard / mouse tray
Height adjustment	slow-flowing spring, parallel linkage for a constant viewing angle
Colours to choose	decorative parts RAL 5013 cobalt blue / RAL 7024 graphite grey aluminum parts RAL 9016 traffic white / RAL 9002 grey white
Max. load capacity support arm	18 kg / 39.7 lbs
Max. load monitor adaption	12 kg / 26.5 lbs
Product weight	5.7 - 6.4 kg / 12.6 - 14.1 lbs (according to dimensions of keyboard tray)
Keyboard tray	300 x 210 mm, 400 x 150 mm, 500 x 200 mm, 580 x 200 mm 11.8 x 8.3", 15.7 x 5.9", 19.7 x 7.9", 22.8 x 7.9"
Balancing range	950 N (1.5 - 6.5 kg / 3.3 - 14.3 lbs); 1300 N (5 - 10.5 kg / 11 - 23.1 lbs); 1750 N (10.5 - 12 kg / 23.1 - 26.5 lbs)
Part number	A-431L-Y.CD_X_T

Fixings

Y | details page 3 and 4



4V

Adapter for vertical wall channel



2F

Fixed rail clamp

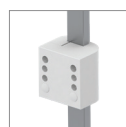

3

Vertical rail clamp

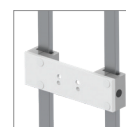

3DR
3TX

Dual vertical rail clamp



1
1B
1F
1C
1V

Fixed / universal pole clamp



13

Adapter for Mindray medical supply units



17

Adapter for Amico pendants & headwalls



9

Adapter for Löwenstein Medical anaesthesia machines



4K

Adapter for anaesthesia machines with existing side channel

Height adjustable arm with space-saving L-bracket

Technical data - keyboard tray 500 x 200 mm / 19.7 x 7.9"

SIDE VIEW

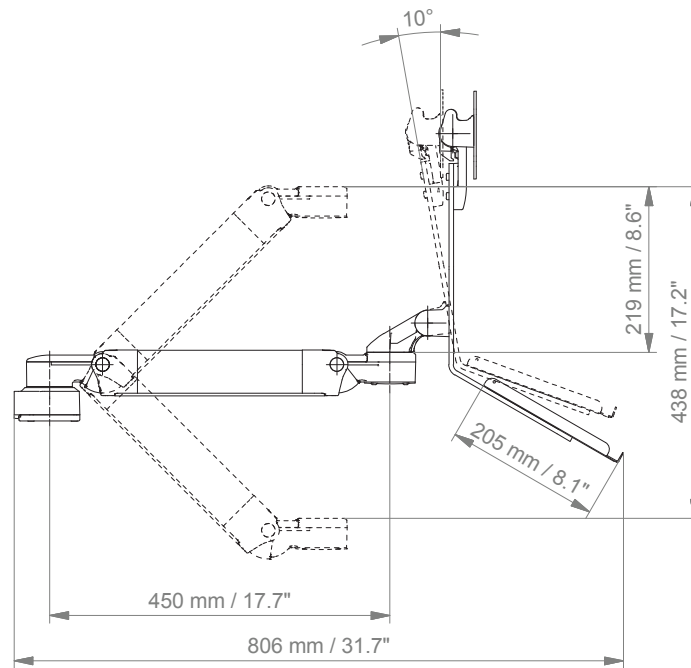

TOP VIEW

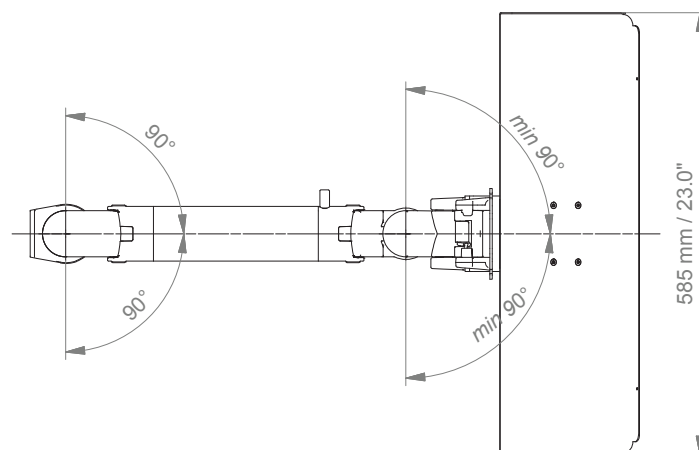

Fixings

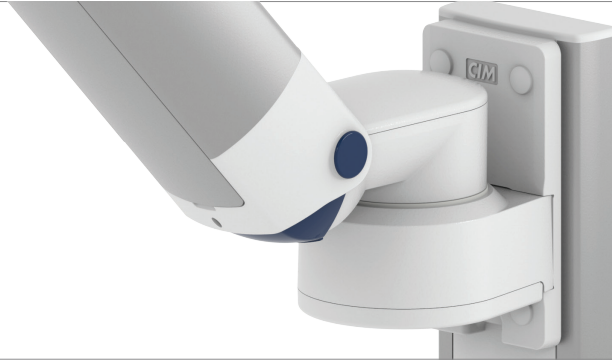









Illustration	Description	Notes	Part no.
	Adapter for vertical wall channel	To mount to CIM wall channel (compatible with GCX channel) Please order separately: CIM wall channel, see catalogue accessoires	4V
	Fixed rail clamp	To mount to horizontal European rails 10 x 25, 8 x 35, 10 x 30, 10 x 50 mm	2F
	Vertical rail clamp	To mount to vertical European rail 10 x 25 mm	3
	Dual vertical rail clamp	To mount to two parallel vertical European rails 10 x 50 mm Distance between rails 150 mm / 5.9", e.g. Dräger pendant Distance between rails 225 mm / 8.9", e.g. Trilux pendant	3DR 3TX
	Fixed pole clamp	To mount to pole \varnothing 25 mm / 1.0" To mount to pole \varnothing 30 mm / 1.2" To mount to pole \varnothing 35 mm / 1.4" To mount to pole \varnothing 38 mm / 1.5"	1 1B 1F 1C
	Universal pole clamp	V-block to mount to pole \varnothing 23 - 40 mm / 0.9 - 1.6"	1V
	Adapter medical supply units	For Mindray medical supply units	13
	Adapter pendants & headwalls	For Amico pendants & headwalls	17

Fixings for anaesthesia machines

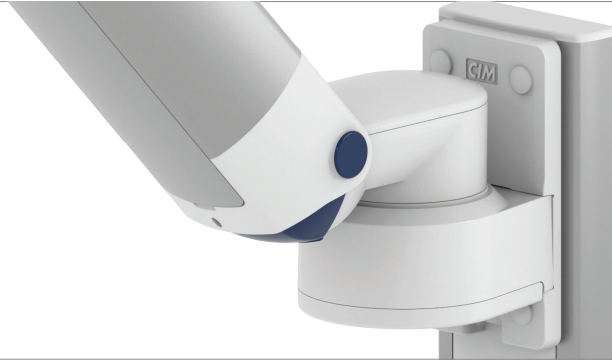







Illustration	Description	Notes	Part no.	
	Adapter for Löwenstein Medical anaesthesia machines	Adapter for Leon / Leon plus	9	
	Adapter for anaesthesia machines (all suppliers)	H 80 mm / 3.1" With existing side channel	4K	
If your anaesthesia machine does not have a side channel already mounted to the machine, please order the following in addition to 4K:				
	Adapter for Dräger	Dräger Primus / Julian / Cato / Fabius GS / Zeus side channel adapter L 127 mm / 5" side channel adapter L 320 mm / 12.6" side channel adapter L 480 mm / 18.9" side channel adapter L 210 mm / 8.3"	DR-J01 DR-J02 DR-J03 DR-J06	
				
		Adapter for GE	GE Avance / Aespire / Aestiva side channel adapter L 200 mm / 7.9" side channel adapter L 350 mm / 13.8"	DX-AES-01 DX-AES-02
				

How to create part numbers

Part numbers can be easily created by following the steps below:

Please replace the letters in **green** with the part no. code as per your requirements.

1. Components' grounding:

A = grounded

2. Choose the arm version required:

431L = height adjustable arm

73130L = extended height adjustable arm

3. Specify where you want to mount the arm and select the fixing (Y):

1V = pole ø 23 - 40 mm / 0.9 - 1.6"

1 = pole ø 25 mm / 1.0"

1B = pole ø 30 mm / 1.2"

1F = pole ø 35 mm / 1.4"

1C = pole ø 38 mm / 1.5"

2F = horizontal rails 10 x 25, 8 x 35, 10 x 30, 10 x 50 mm

3 = vertical rail 10 x 25 mm

3DR = dual vertical rails, distance 150 mm/ 5.9"

3TX = dual vertical rails, distance 225 mm/ 8.9"

4V = vertical wall channel

13 = Mindray medical supply units

17 = Amico pendants & headwalls

9 = Löwenstein Medical anaesthesia machine

4K = anaesthesia machine with existing channel

4. Choose the colour requested for decorative parts (C):

gr = RAL 7024 (graphite grey)

bl = RAL 5013 (cobalt blue)

How to create part numbers

5. Choose the colour requested for the aluminium die-cast parts (D):

- 1 = RAL 9016 (traffic white)
- 2 = RAL 9002 (grey white)

6. Specify the spring depending on the weight of your monitor/ device - only with height adjustable arms (X):

Please note that the weight range of the individual springs may vary depending on the bracket (X).

Pneumatic Springs Explained:

The weight ranges of the pneumatic springs shown in our catalogues relate to the minimum and maximum weights of the products that can be added to the arm, for a perfectly balanced solution. The weight ranges can vary with the same pneumatic springs, as the overall weights placed on the front of the arms have to be considered. The total weight not only reflects the actual monitor weight, but also includes monitor adaptations, brackets and/ or trays. When choosing the pneumatic spring, please consider the weight of your monitor/ device only.

L-Bracket

- 95 = 1.5 - 6.5 kg / 3.3 - 14.3 lbs
- 130 = 5 - 10.5 kg / 11 - 23.1 lbs
- 175 = 10.5 - 12 kg / 23.1 - 26.5 lbs

7. Specify the requested size of the keyboard tray and mouse (T):

- 30S = 300 x 210 mm / 11.8 x 8.3", magnetic
- 40S = 400 x 150 mm / 15.7 x 5.9", magnetic
- 50S = 500 x 200 mm / 19.7 x 7.9", magnetic
- 58S = 580 x 200 mm / 22.8 x 7.9", magnetic

Example

01 Grounding	02 Arm version	03 Fixing	04 & 05 Colour	06 Spring tension	07 Keyboard tray
A	- 431L	- Y	. CD	- X	- T
A	- 431L	- 4V	. gr1	- 95	- 30

Product highlights

Non-height adjustable arm

Pivot and extended pivot arms offer **full cable integration** and easy cleaning for **infection control** in all critical care areas in the clinical environment. Our **5-years warranty** guarantees reliable, trouble-free and maintenance-free operation. The swivel function at the fixing point as well as the **tilt/ swivel function** of the monitor adaptation offers optimum positioning of your device. The extended pivot arm is a two-part arm with central pivot point between the two arm sections. All bottom-mounted monitors have the safety feature of a **20° tilt stop**.

Height adjustable arm

The height adjustable arm offers **full cable integration**, one-wipe clean surfaces and our **5-year warranty** on the entirety of the product. Vertically and horizontally adjustable, the arm offers optimal positioning of your device. A constant viewing angle when vertically adjusted is guaranteed by a parallel linkage. **Weight-optimized springs counter-balance** the monitor without making any adjustments. All bottom-mounted monitors have the safety feature of a **20° tilt stop**. Individual rotational stops may be integrated in any joint.

To provide the perfect combination of arm and monitor, the CIM articulated height adjustable arm has a simple quarter-turn lock to hold the arm safely in position when removing the monitor. Furthermore the arm is equipped with the unique safety feature of a slow-release gas spring. Should anybody try to remove the monitor before locking the arm in position, the arm will only rise at a slow and even tempo.



SAFETY

General notes

Monitor Adaptations

The monitor adaptation VESA 75/ 100 is provided with a spring for counter-balance.

Components' grounding

All arms with integrated cable management are equipped with **component grounding**. No grounding is required for arms with external or semi-integrated cable management with cables not being led through joints.

Load capacity

All **height adjustable arms** have a load capacity of 22 kg / 48.5 lbs. Rear mounted monitor adaptations and horizontally mounted 5" plunge plates accept a maximum monitor weight of 18 kg / 39.7 lbs. An additional 4 kg / 8.8 lbs may be mounted on a down post underneath the front swivel part. Depending on material and tensile factor all weight indications have a 4-fold and/ or 6-fold safety factor according to IEC 60601-1 standards.

Custom-designed solutions and MRI applications

Please contact us for **custom-designed** solutions.

Product marking

All CIM products are CE marked. As **medical product risk class 1** they conform with the regulations (EU) 2017/745 (MDR) and IEC 60601-1, 3rd Edition. The current standard IEC 60601-1 for electrical and mechanical safety is the 3rd Edition. Other standards of the IEC 60601 series are not applicable to our products, regardless of their version.