

# High position height adjustable arm



<b>Monitor adaption</b>	prepared to accept Philips table top mount
<b>Height adjustment</b>	slow-flowing spring, parallel linkage for a constant viewing angle
<b>Colours to choose</b>	decorative parts RAL 5013 cobalt blue / RAL 7024 graphite grey aluminum parts RAL 9016 traffic white / RAL 9002 grey white
<b>Max. load capacity support arm</b>	22 kg / 48.5 lbs
<b>Max. load monitor adaption</b>	22 kg / 48.5 lbs
<b>Product weight</b>	3.7 kg / 8.2 lbs
<b>Balancing range</b>	600 N (2-5 kg / 4.4-11 lbs ); 950 N (4-9 kg / 8.8-19.8 lbs); 1300 N (7.5-13 kg / 16.5-28.7 lbs); 1750 N (13-16 kg / 28.7-35.3 lbs); 2200 N (16-22 kg / 35.3-48.5 lbs)
<b>Part number</b>	A-531PH-Y.CD_X

## Fixings



4U

Adapter for vertical wall channel

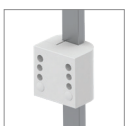

3

Vertical rail clamp



3DR  
3TX

Dual vertical rail clamp



1  
1F  
1C  
1V

Fixed / universal pole clamp



13

Adapter for Mindray medical supply units



17

Adapter for Amico pendants & headwalls

# High position height adjustable arm

## Technical data

---

### SIDE VIEW

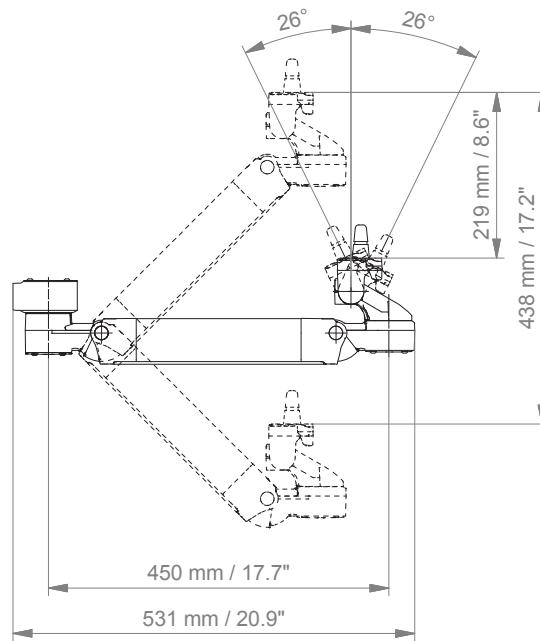

### TOP VIEW

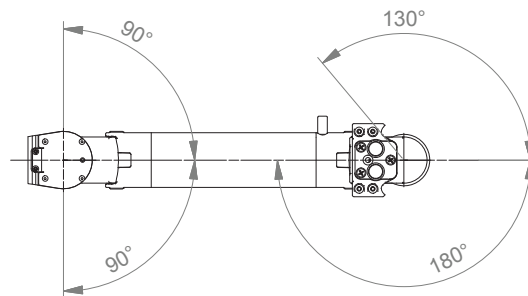

## Fixings

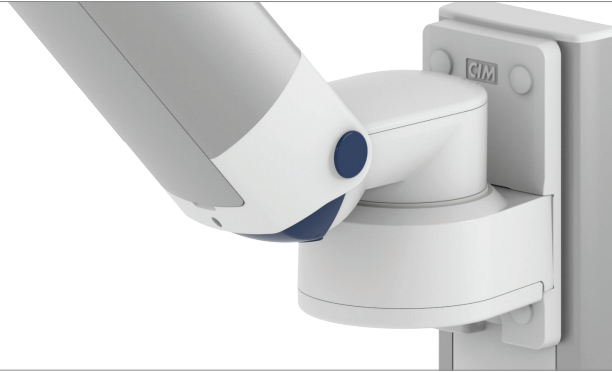









Illustration	Description	Notes	Part no.
	Adapter for vertical wall channel	To mount to CIM wall channel (compatible with GCX channel) For arms with high mounting positions Please order separately: CIM wall channel, see catalogue accessoires	4V 4U
	Fixed rail clamp	To mount to horizontal European rails 10 x 25, 8 x 35, 10 x 30, 10 x 50 mm	2F
	Vertical rail clamp	To mount to vertical European rail 10 x 25 mm	3
	Dual vertical rail clamp	To mount to two parallel vertical European rails 10 x 50 mm Distance between rails 150 mm / 5.9", e.g. Dräger pendant Distance between rails 225 mm / 8.9", e.g. Trilux pendant	3DR 3TX
	Fixed pole clamp	To mount to pole $\varnothing$ 25 mm / 1.0" To mount to pole $\varnothing$ 35 mm / 1.4" To mount to pole $\varnothing$ 38 mm / 1.5"	1 1F 1C
	Universal pole clamp	V-block to mount to pole $\varnothing$ 23 - 40 mm / 0.9 - 1.6"	1V
	Adapter medical supply units	For Mindray medical supply units	13
	Adapter pendants & headwalls	For Amico pendants & headwalls	17

## Fixings for anaesthesia machines

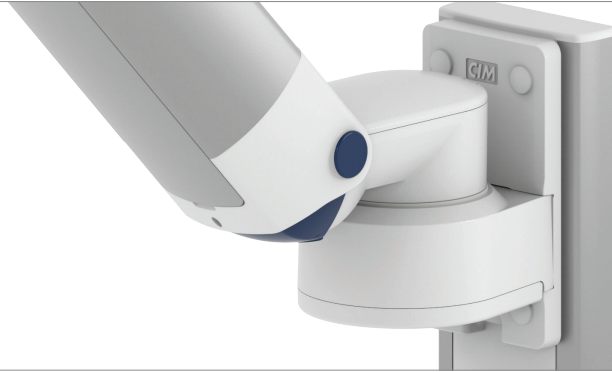

Illustration	Description	Notes	Part no.
	Adapter for Löwenstein Medical anaesthesia machines	Adapter for Leon / Leon plus	9
	Adapter for anaesthesia machines (all suppliers)	H 80 mm / 3.1" With existing side channel	4K
<b>If your anaesthesia machine does not have a side channel already mounted to the machine, please order the following in addition to 4K:</b>			
	Adapter for Dräger	Dräger Primus / Julian / Cato / Fabius GS / Zeus side channel adapter L 127 mm / 5" side channel adapter L 320 mm / 12.6"	DR-J01 DR-J02
	Adapter for GE	GE Avance / Aespire / Aestiva side channel adapter L 200 mm / 7.9"	DX-AES-01

# How to create part numbers

Part numbers can be easily created by following the steps below:

Please replace the letters in **green** with the part no. code as per your requirements.

## 1. Components' grounding:

A = grounded

## 2. Choose the arm version required:

224PH / 230PH = pivot arm  
 33030PH = extended pivot arm light duty  
 H33030PH = extended pivot arm heavy duty  
 431PH = height adjustable arm  
 73130PH = extended height adjustable arm  
 531PH = high position height adjustable arm  
 83130PH = extended high position height adjustable arm  
 224FMS / 230FMS = pivot arm, FMS interface  
 32424FMS / 33030FMS = extended pivot arm light duty, FMS interface  
 224MP2 / 230MP2 = pivot arm, MP2/ X2/ X3 interface  
 224MP2PS / 230MP2PS = pivot arm, MP2/ X2/ X3 interface with power supply enclosure  
 33030MP2 = extended pivot arm light duty, MP2/ X2/ X3 interface  
 33030MP2PS = extended pivot arm light duty, MP2/ X2/ X3 interface with power supply

## 3. Specify where you want to mount the arm and select the fixing (Y):

1V = pole ø 23 - 40 mm / 0.9 - 1.6"  
 1 = pole ø 25 mm / 1.0"  
 1F = pole ø 35 mm / 1.4"  
 1C = pole ø 38 mm / 1.5"  
 2F = horizontal rails 10 x 25, 8 x 35, 10 x 30, 10 x 50 mm  
 3 = vertical rail 10 x 25 mm  
 3DR = dual vertical rails, distance 150 mm/ 5.9"  
 3TX = dual vertical rails, distance 225 mm/ 8.9"  
 4V = vertical wall channel  
 4U = vertical wall channel for arms with high mounting position  
 13 = Mindray medical supply units  
 17 = Amico pendants & headwalls  
 9 = Löwenstein Medical anaesthesia machine  
 4K = anaesthesia machine with existing channel

## How to create part numbers

---

### 4. Choose the colour requested for decorative parts (C):

gr = RAL 7024 (graphite grey)  
 bl = RAL 5013 (cobalt blue)

### 5. Choose the colour requested for the aluminium die-cast parts (D):

1 = RAL 9016 (traffic white)  
 2 = RAL 9002 (grey white)

### 6. Specify the spring depending on the weight of your monitor/ device - only with height adjustable arms (X):

60 = 2 - 5 kg / 4.4 - 11 lbs  
 95 = 4 - 9 kg / 8.8 - 19.8 lbs  
 130 = 7.5 - 13 kg / 16.5 - 28.7 lbs  
 175 = 13 - 16 kg / 28.7 - 35.3 lbs  
 220 = 16 - 22 kg / 35.3 - 48.5 lbs

---

## Example

01 Grounding		02 Arm version		03 Fixing		04 & 05 Colour		06 Spring tension
A	-	431PH	-	Y	.	CD	-	X
A	-	431PH	-	4V	.	gr1	-	95

## General notes

---

### Monitor Adaptations

All mounting systems for **Philips IntelliVue series** are prepared to accept the Philips table top mount.

Mounting solutions for the **Efficia series** and **Sure Signs / Vital Signs** are shown in the catalogue “5” plunge plate adaptation”.

### Please note!

The Philips table top mount must be ordered separately by Philips.

### Components' grounding

All arms with integrated cable management are equipped with **component grounding**. No grounding is required for arms with external or semi-integrated cable management with cables not being led through joints.

### Load capacity

All **height adjustable arms** have a load capacity of 22 kg / 48.5 lbs. Rear mounted monitor adaptations and horizontally mounted 5” plunge plates accept a maximum monitor weight of 18 kg / 39.7 lbs. An additional 4 kg / 8.8 lbs may be mounted on a down post underneath the front swivel part. Depending on material and tensile factor all weight indications have a 4-fold and / or 6-fold safety factor according to EN 60601-1, 3rd Edition regulations.

### Custom-designed solutions and MRI applications

Please contact us for **custom-designed** solutions.

### Product marking

All CIM products are CE marked. As **medical product risk class 1** and they conform with the regulations MDD 93/42 ECC and EN 60601-1, 3rd Edition. TUEV reports for numerous products especially for anaesthesia applications guarantee electrical and mechanical safety of our products and are available upon request.

## Product highlights

---

### Non-height adjustable arm

Pivot and extended pivot arms offer **full cable integration** and easy cleaning for **infection control** in all critical care areas in the clinical environment. Our **5-years warranty** guarantees reliable, trouble-free and maintenance-free operation. The swivel function at the fixing point as well as the **tilt/ swivel function** of the monitor adaptation offers optimum positioning of your device. The extended pivot arm is a two-part arm with central pivot point between the two arm sections. All bottom-mounted monitors have the safety feature of a **20° tilt stop**.

### Height adjustable arm

The height adjustable arm offers **full cable integration**, one-wipe clean surfaces and our **5-year warranty** on the entirety of the product. Vertically and horizontally adjustable, the arm offers optimal positioning of your device. A constant viewing angle when vertically adjusted is guaranteed by a parallel linkage. **Weight-optimized springs counter-balance** the monitor without making any adjustments. All bottom-mounted monitors have the safety feature of a **20° tilt stop**. Individual rotational stops may be integrated in any joint.

To provide the perfect combination of arm and monitor, the CIM articulated height adjustable arm has a simple quarter-turn lock to hold the arm safely in position when removing the monitor. Furthermore the arm is equipped with the unique safety feature of a slow-release gas spring. Should anybody try to remove the monitor before locking the arm in position, the arm will only rise at a slow and even tempo.

**SAFETY**