

# Support arm pivot



**Monitor adaption**

5" plunge plate

**Colours to choose** CD

decorative parts RAL 5013 cobalt blue / RAL 7024 graphite grey  
 aluminum parts RAL 9016 traffic white / RAL 9002 grey white

**Max. load capacity support arm**

18 kg / 39.7 lbs

**Max. load monitor adaption**

18 kg / 39.7 lbs

**Product weight**

arm type 240	arm type 300
1.8 kg/ 4.0 lbs	1.9 kg/ 4.2 lbs

**Part number**

arm type 240	arm type 300
A-224A-Y.CD	A-230A-Y.CD

**Fixings Y**

details page 3



4S

Adapter for vertical wall channel



2F

Horizontal rail clamp

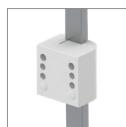

3

Vertical rail clamp



1V

Universal pole clamp



1  
1B  
1F  
1C

Fixed pole clamp



13

Adapter for Mindray medical supply units



17

Adapter for Amico pendants & headwalls



19

Adapter for Dräger Ambia pendants & headwalls

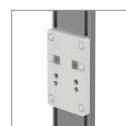

9

Adapter for Löwenstein Medical / ITD / mounting channel

# Support arm pivot

Technical data - arm type 300

---

SIDE VIEW

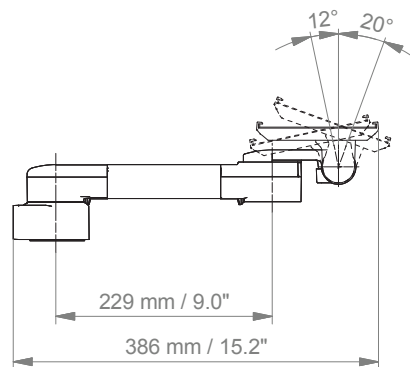



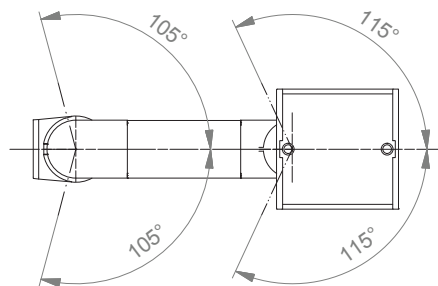





TOP VIEW

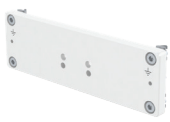

## Fixings Y



Illustration	Description	Notes	Weight	Part no.
	Adapter for vertical wall channel	To mount to CIM wall channel (compatible with GCX channel) Please order separately: CIM wall channel, see catalogue accessoires	0.6 kg / 1.3 lbs	4S
	Horizontal rail clamp	To mount to horizontal European rails 10 x 25, 8 x 35, 10 x 30, 10 x 50 mm	1.1 kg / 2.4 lbs	2F
	Vertical rail clamp	To mount to vertical European rail 10 x 25 mm	0.5 kg / 1.1 lbs	3
	Universal pole clamp	V-block to mount to pole $\varnothing$ 23 - 40 mm / 0.9 - 1.6"	0.6 kg / 1.3 lbs	1V
	Fixed pole clamp	To mount to pole $\varnothing$ 25 mm / 1.0" To mount to pole $\varnothing$ 30 mm / 1.2" To mount to pole $\varnothing$ 35 mm / 1.4" To mount to pole $\varnothing$ 38 mm / 1.5"	0.3 kg / 0.7 lbs 0.4 kg / 0.9 lbs 0.4 kg / 0.9 lbs 0.4 kg / 0.9 lbs	1 1B 1F 1C
	Adapter medical supply units	For Mindray medical supply units	0.8 kg / 1.8 lbs	13
	Adapter pendants & headwalls	For Amico pendants & headwalls	0.6 kg / 1.3 lbs	17
	Adapter pendants & headwalls	For Dräger Ambia pendants & headwalls	0.6 kg / 1.3 lbs	19
	Adapter pendants & headwalls	For Löwenstein Medical / ITD / mounting channels	0.4 kg / 0.9 lbs	9

# How to create part numbers

Part numbers can be easily created by following the steps below:

Please replace the letters in **green** with the part no. code as per your requirements.

## 1. Components' grounding:

A = grounded

## 2. Choose the arm version required:

224A / 230A = support arm pivot  
 33030A = extended pivot arm light duty  
 H33030A = extended pivot arm heavy duty  
 431A = height adjustable arm  
 73130A = extended height adjustable arm  
 531A = high position height adjustable arm  
 83130A = extended high position height adjustable arm

## 3. Specify where you want to mount the arm and select the fixing (Y):

1V = pole ø 23 - 40 mm / 0.9 - 1.6"  
 1 = pole ø 25 mm / 1.0"  
 1B = pole ø 30 mm / 1.2"  
 1F = pole ø 35 mm / 1.4"  
 1C = pole ø 38 mm / 1.5"  
 2F = horizontal rails 10 x 25, 8 x 35, 10 x 30, 10 x 50 mm  
 3 = vertical rail 10 x 25 mm  
 4S = vertical wall channel  
 9 = Löwenstein Medical / ITD / mounting channel  
 13 = Mindray medical supply units  
 17 = Amico pendants & headwalls  
 19 = Dräger Ambia pendants & headwalls

## 4. Choose the colour requested for decorative parts (C):

gr = RAL 7024 (graphite grey)  
 bl = RAL 5013 (cobalt blue)



## How to create part numbers

---

### 5. Choose the colour requested for the aluminium die-cast parts (D):

- 1 = RAL 9016 (traffic white)  
 2 = RAL 9002 (grey white)

### 6. Specify the spring depending on the weight of your monitor/ device - only with height adjustable arms (X):

- 60 = 2 - 5 kg / 4.4 - 11 lbs  
 95 = 4 - 9 kg / 8.8 - 19.8 lbs  
 110 = 4.5 - 12.5 kg / 9.9 - 27.6 lbs  
 130 = 7.5 - 13 kg / 16.5 - 28.7 lbs  
 160 = 12.5 - 19 kg / 27.6 - 41.9 lbs  
 175 = 13 - 16 kg / 28.7 - 35.3 lbs  
 220 = 16 - 22 kg / 35.3 - 48.5 lbs
- 

## Example

01 Grounding	02 Arm version	03 Fixing	04 & 05 Colour	06 Spring tension
A	- 431A	- Y	. CD	- X
A	- 431A	- 4S	. gr1	- 95

## General notes

---

### Monitor adaptations

The 5" plunge plate is intended to accept bottom-mounted monitors. Please note that a special mounting adapter is required for some monitors. The mounting adapter is mounted to the bottom and slides into the 5" plunge plate. For monitors from **Dräger** and **GE Healthcare** no special mounting adapters are required. For the monitors from **Mindray**, **Nihon Kohden**, **Spacelabs** and **Philips Sure Signs/ Vital Signs** mounting adapters are necessary to mount the monitors. For **Philips IntelliVue series** please refer to the separate catalogue: Philips Monitoring IntelliVue Series.

### Components' grounding

All arms with integrated cable management are equipped with **component grounding**. No grounding is required for arms with external or semi-integrated cable management with cables not being led through joints.

### Load capacity

All **height adjustable arms** have a load capacity of 22 kg / 48.5 lbs. Rear mounted monitor adaptations and horizontally mounted 5" plunge plates accept a maximum monitor weight of 18 kg / 39.7 lbs. An additional 4 kg / 8.8 lbs may be mounted on a down post underneath the front swivel part. Depending on material and tensile factor all weight indications have a 4-fold and/ or 6-fold safety factor according to IEC 60601-1 standards.

### Custom-designed solutions and MRI applications

Please contact us for **custom-designed** solutions.

### Product marking

All products which are classified as medical product risk class 1 are CE marked. As **medical product risk class 1** they are conform with the regulations (EU) 2017/745 (MDR) and IEC 60601-1. Other standards of the IEC 60601 series are not applicable to our products, regardless of their version.

**MD** A stand-alone product that is already classified as a medical product class 1 before being integrated into an overall medical device. The product is CE-marked. A declaration of conformity is available.

~~MD~~ Accessories or spare parts that have no independent function and are therefore not subject to the MDR. These products are not CE-marked. A declaration of conformity is not required.

### Warranty

All CIM products have a 5-year warranty to be free of defects in material and functionality from the date of delivery.

---

## How to find the right product for your needs?

No problem with our configurator

<https://cim-configurator.com>



## Product highlights

---

### Non-height adjustable arm

Pivot and extended pivot arms offer **full cable integration** and easy cleaning for **infection control** in all critical care areas in the clinical environment. Our **5-years warranty** guarantees reliable, trouble-free and maintenance-free operation. The swivel function at the fixing point as well as the **tilt/ swivel function** of the monitor adaptation offers optimum positioning of your device. The extended pivot arm is a two-part arm with central pivot point between the two arm sections. All bottom-mounted monitors have the safety feature of a **20° tilt stop**.

### Height adjustable arm

The height adjustable arm offers **full cable integration**, one-wipe clean surfaces and our **5-year warranty** on the entirety of the product. Vertically and horizontally adjustable, the arm offers optimal positioning of your device. A constant viewing angle when vertically adjusted is guaranteed by a parallel linkage. **Weight-optimized springs counter-balance** the monitor without making any adjustments. All bottom-mounted monitors have the safety feature of a **20° tilt stop**. Individual rotational stops may be integrated in any joint.

To provide the perfect combination of arm and monitor, the CIM articulated height adjustable arm has a simple quarter-turn lock to hold the arm safely in position when removing the monitor. Furthermore the arm is equipped with the unique safety feature of a slow-release gas spring. Should anybody try to remove the monitor before locking the arm in position, the arm will only rise at a slow and even tempo.

**SAFETY**