

Support arm pivot cube



Monitor adaption

quick release base plate

Colours to choose CD

decorative parts RAL 5013 cobalt blue / RAL 7024 graphite grey
 aluminum parts RAL 9016 traffic white / RAL 9002 grey white

Max. load capacity support arm

18 kg / 39.7 lbs

Max. load monitor adaption

18 kg / 39.7 lbs

Product weight

arm type 240 1.6 kg / 3.5 lbs
 arm type 300 1.8 kg / 4.0 lbs

Part number

A-224Q-Y.CD arm type 240
 A-230Q-Y.CD arm type 300
 Z-QR-C.D quick release adapter plate VESA 75

Fixings Y

details page 4



4S

Adapter for vertical wall channel



2F

Horizontal rail clamp

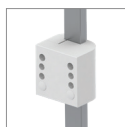

3

Vertical rail clamp



1V

Universal pole clamp



1
1B
1F
1C

Fixed pole clamp



13

Adapter for Mindray medical supply units



17

Adapter for Amico pendants & headwalls



19

Adapter for Dräger Ambia pendants & headwalls

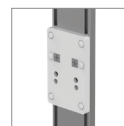

9

Adapter for Löwenstein Medical / ITD / mounting channel

Support arm pivot cube

Technical data – arm type 300

SIDE VIEW

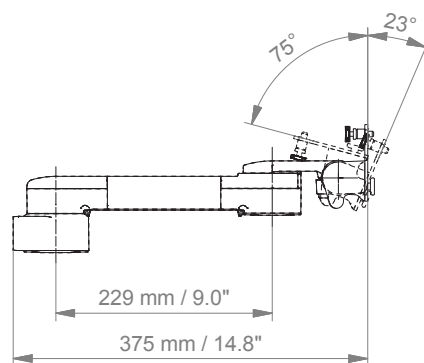

TOP VIEW

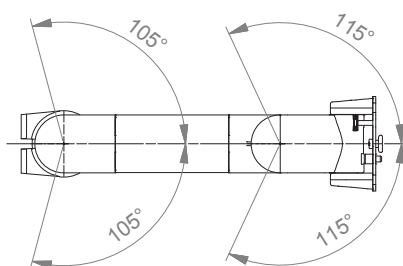

Adapter plate

VESA 75 Quick release adapter plate (Z-QR-C.D)









The adapter plate shown is mounted to the rear side of the monitor's hole pattern 75 x 75 mm (2.9 x 2.9"). The quick release adapter plate has to be ordered separately.

Product weight: 0.2 kg / 0.4 lbs

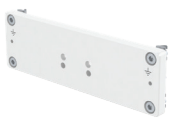

Fixings Y



Illustration	Description	Notes	Weight	Part no.
	Adapter for vertical wall channel	To mount to CIM wall channel (compatible with GCX channel) Please order separately: CIM wall channel, see catalogue accessoires	0.6 kg / 1.3 lbs	4S
	Horizontal rail clamp	To mount to horizontal European rails 10 x 25, 8 x 35, 10 x 30, 10 x 50 mm	1.1 kg / 2.4 lbs	2F
	Vertical rail clamp	To mount to vertical European rail 10 x 25 mm	0.5 kg / 1.1 lbs	3
	Universal pole clamp	V-block to mount to pole \varnothing 23 - 40 mm / 0.9 - 1.6"	0.6 kg / 1.3 lbs	1V
	Fixed pole clamp	To mount to pole \varnothing 25 mm / 1.0" To mount to pole \varnothing 30 mm / 1.2" To mount to pole \varnothing 35 mm / 1.4" To mount to pole \varnothing 38 mm / 1.5"	0.3 kg / 0.7 lbs 0.4 kg / 0.9 lbs 0.4 kg / 0.9 lbs 0.4 kg / 0.9 lbs	1 1B 1F 1C
	Adapter medical supply units	For Mindray medical supply units	0.8 kg / 1.8 lbs	13
	Adapter pendants & headwalls	For Amico pendants & headwalls	0.6 kg / 1.3 lbs	17
	Adapter pendants & headwalls	For Dräger Ambia pendants & headwalls	0.6 kg / 1.3 lbs	19
	Adapter pendants & headwalls	For Löwenstein Medical / ITD / mounting channels	0.4 kg / 0.9 lbs	9

How to create part numbers

Part numbers can be easily created by following the steps below:

Please replace the letters in **green** with the part no. code as per your requirements.

1. Components' grounding:

S	=	not grounded
A	=	grounded

2. Choose the arm version required:

910Q	=	flush mount qube
224Q / 230Q	=	support arm pivot qube
224A / 230A	=	support arm pivot qube with docking station
33030Q	=	extended pivot arm light duty qube
33030A	=	extended pivot arm light duty qube with docking station
431Q	=	height adjustable arm qube
431A	=	height adjustable arm qube with docking station
73130Q	=	extended height adjustable arm qube
73130A	=	extended height adjustable arm qube with docking station

3. Specify where you want to mount the arm and select the fixing (Y):

1V	=	pole ø 23 - 40 mm / 0.9 - 1.6"
1	=	pole ø 25 mm / 1.0"
1B	=	pole ø 30 mm / 1.2"
1F	=	pole ø 35 mm / 1.4"
1C	=	pole ø 38 mm / 1.5"
2F	=	horizontal rails 10 x 25, 8 x 35, 10 x 30, 10 x 50 mm
3	=	vertical rail 10 x 25 mm
4S	=	vertical wall channel
9	=	Löwenstein Medical / ITD / mounting channel
13	=	Mindray medical supply units
17	=	Amico pendants & headwalls
19	=	Dräger Ambia pendants & headwalls

How to create part numbers

4. Choose the colour requested for decorative parts (C):

gr = RAL 7024 (graphite grey)
 bl = RAL 5013 (cobalt blue)

5. Choose the colour requested for the aluminium die-cast parts (D):

1 = RAL 9016 (traffic white)
 2 = RAL 9002 (grey white)

6. Specify the spring depending on the weight of your monitor/ device - only with height adjustable arms (X):

95 = 4 - 9 kg / 8.8 - 19.8 lbs

Example

01 Grounding		02 Arm version		03 Fixing		04 & 05 Colour		06 Spring tension
A	-	431Q	-	Y	.	CD	-	X
A	-	431Q	-	4S	.	gr1	-	95

General notes

Monitor Adaptations

The quick release monitor adaptation with adapter plate for VESA 75/75 (part no. Z-QR-C.D) allows a quick change of the monitor. Please note that the quick release adapter plate has to be ordered separately.

The 5" plunge plate is used for bottom-mounted monitors. A monitor-specific adapter plate (part no. Z-AP-G), which is mounted underneath the monitor and slid into the 5" plunge plate, has to be ordered separately.

Components' grounding

All arms with integrated cable management are equipped with **component grounding**. No grounding is required for arms with external or semi-integrated cable management with cables not being led through joints.

Load capacity

All **height adjustable arms** have a load capacity of 22 kg / 48.5 lbs. Rear mounted monitor adaptations and horizontally mounted 5" plunge plates accept a maximum monitor weight of 18 kg / 39.7 lbs. An additional 4 kg / 8.8 lbs may be mounted on a down post underneath the front swivel part. Depending on material and tensile factor all weight indications have a 4-fold and/ or 6-fold safety factor according to IEC 60601-1 standards.

Custom-designed solutions and MRI applications

Please contact us for **custom-designed** solutions.

Product marking

All products which are classified as medical product risk class 1 are CE marked. As **medical product risk class 1** they are conform with the regulations (EU) 2017/745 (MDR) and IEC 60601-1. Other standards of the IEC 60601 series are not applicable to our products, regardless of their version.

MD A stand-alone product that is already classified as a medical product class 1 before being integrated into an overall medical device. The product is CE-marked. A declaration of conformity is available.

~~MD~~ Accessories or spare parts that have no independent function and are therefore not subject to the MDR. These products are not CE-marked. A declaration of conformity is not required.

Warranty

All CIM products have a 5-year warranty to be free of defects in material and functionality from the date of delivery.

How to find the right product for your needs?

No problem with our configurator

<https://cim-configurator.com>



Product highlights

Non-height adjustable arm

Pivot and extended pivot arms offer **full cable integration** and easy cleaning for **infection control** in all critical care areas in the clinical environment. Our **5-years warranty** guarantees reliable, trouble-free and maintenance-free operation. The swivel function at the fixing point as well as the **tilt/ swivel function** of the monitor adaptation offers optimum positioning of your device. The extended pivot arm is a two-part arm with central pivot point between the two arm sections. All bottom-mounted monitors have the safety feature of a **20° tilt stop**.

Height adjustable arm

The height adjustable arm offers **full cable integration**, one-wipe clean surfaces and our **5-year warranty** on the entirety of the product. Vertically and horizontally adjustable, the arm offers optimal positioning of your device. A constant viewing angle when vertically adjusted is guaranteed by a parallel linkage. **Weight-optimized springs counter-balance** the monitor without making any adjustments. All bottom-mounted monitors have the safety feature of a **20° tilt stop**. Individual rotational stops may be integrated in any joint.

To provide the perfect combination of arm and monitor, the CIM articulated height adjustable arm has a simple quarter-turn lock to hold the arm safely in position when removing the monitor. Furthermore the arm is equipped with the unique safety feature of a slow-release gas spring. Should anybody try to remove the monitor before locking the arm in position, the arm will only rise at a slow and even tempo.



SAFETY