

Extended pivot arm light duty

MD

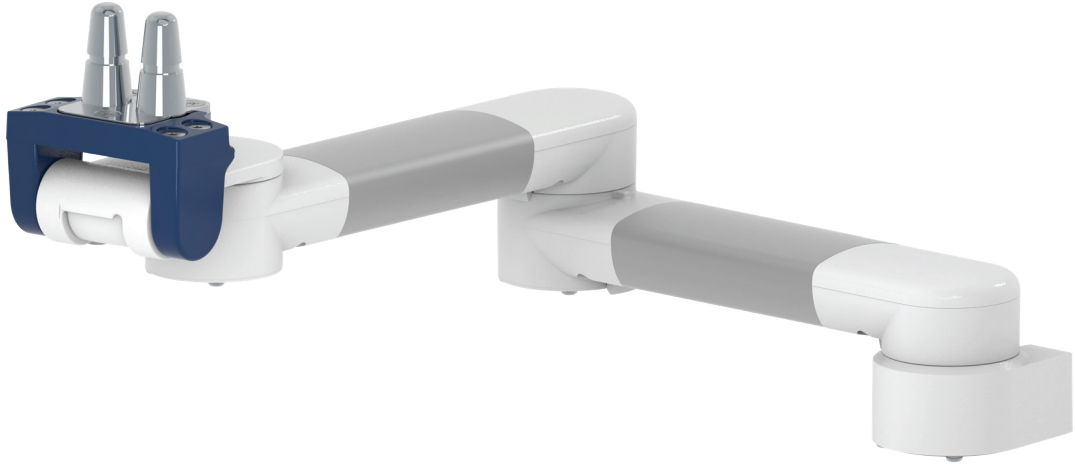

Monitor adaption

prepared to accept Philips table top mount

Colours to choose **CD**

decorative parts RAL 5013 cobalt blue / RAL 7024 graphite grey
 aluminum parts RAL 9016 traffic white / RAL 9002 grey white

Max. load capacity support arm

8 kg / 17.6 lbs

Max. load monitor adaption

8 kg / 17.6 lbs

Product weight

2.7 kg / 5.9 lbs

Part number

A-33030PH-Y.CD

Fixings **Y**

details page 3



4S

Adapter for vertical wall channel



2F

Horizontal rail clamp

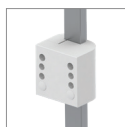

3

Vertical rail clamp



1V

Universal pole clamp



1
1B
1F
1C

Fixed pole clamp



13

Adapter for Mindray medical supply units



17

Adapter for Amico pendants & headwalls



19

Adapter for Dräger Ambia pendants & headwalls

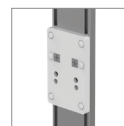

9

Adapter for Löwenstein Medical / ITD / mounting channel

Extended pivot arm light duty

Technical data

SIDE VIEW

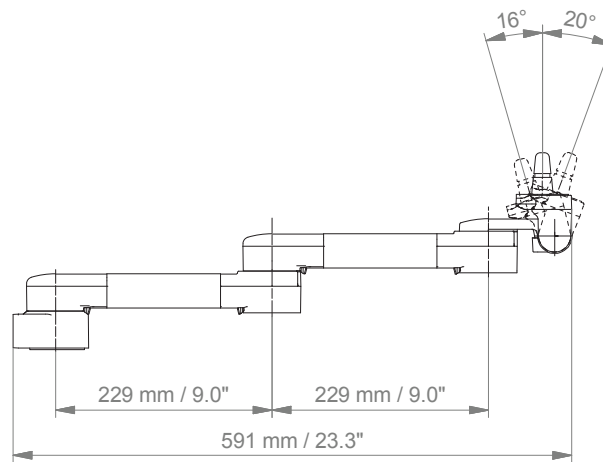



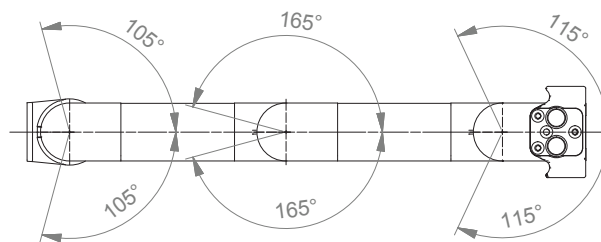





TOP VIEW

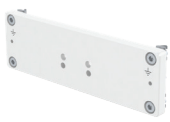

Fixings



Illustration	Description	Notes	Weight	Part no.
	Adapter for vertical wall channel	To mount to CIM wall channel (compatible with GCX channel) Please order separately: CIM wall channel, see catalogue accessoires	0.6 kg / 1.3 lbs	4S
	Horizontal rail clamp	To mount to horizontal European rails 10 x 25, 8 x 35, 10 x 30, 10 x 50 mm	1.1 kg / 2.4 lbs	2F
	Vertical rail clamp	To mount to vertical European rail 10 x 25 mm	0.5 kg / 1.1 lbs	3
	Universal pole clamp	V-block to mount to pole \varnothing 23 - 40 mm / 0.9 - 1.6"	0.6 kg / 1.3 lbs	1V
	Fixed pole clamp	To mount to pole \varnothing 25 mm / 1.0" To mount to pole \varnothing 30 mm / 1.2" To mount to pole \varnothing 35 mm / 1.4" To mount to pole \varnothing 38 mm / 1.5"	0.3 kg / 0.7 lbs 0.4 kg / 0.9 lbs 0.4 kg / 0.9 lbs 0.4 kg / 0.9 lbs	1 1B 1F 1C
	Adapter medical supply units	For Mindray medical supply units	0.8 kg / 1.8 lbs	13
	Adapter pendants & headwalls	For Amico pendants & headwalls	0.6 kg / 1.3 lbs	17
	Adapter pendants & headwalls	For Dräger Ambia pendants & headwalls	0.6 kg / 1.3 lbs	19
	Adapter pendants & headwalls	For Löwenstein Medical / ITD / mounting channels	0.4 kg / 0.9 lbs	9

How to create part numbers

Part numbers can be easily created by following the steps below:

Please replace the letters in **green** with the part no. code as per your requirements.

1. Components' grounding:

A = grounded

2. Choose the arm version required:

224PH / 230PH	=	pivot arm
33030PH	=	extended pivot arm light duty
H33030PH	=	extended pivot arm heavy duty
431PH	=	height adjustable arm
73130PH	=	extended height adjustable arm
531PH	=	high position height adjustable arm
83130PH	=	extended high position height adjustable arm
224FMS / 230FMS	=	pivot arm, FMS interface
32424FMS / 33030FMS	=	extended pivot arm light duty, FMS interface
224MP2 / 230MP2	=	pivot arm, MP2/ X2/ X3 interface
224MP2PS / 230MP2PS	=	pivot arm, MP2/ X2/ X3 interface with power supply enclosure
33030MP2	=	extended pivot arm light duty, MP2/ X2/ X3 interface
33030MP2PS	=	extended pivot arm light duty, MP2/ X2/ X3 interface with power supply
224X2X3 / 230X2X3	=	pivot arm, without cable hook, MP2/ X2/ X3 interface
33030X2X3	=	extended pivot arm light duty, without cable hook, MP2/ X2/ X3 interface
431X2X3	=	height adjustable arm, without cable hook, MP2/ X2/ X3 interface with power supply enclosure
73130X2X3	=	extended height adjustable arm, without cable hook, MP2/ X2/ X3 interface

3. Specify where you want to mount the arm and select the fixing (Y):

1V	=	pole ø 23 - 40 mm / 0.9 - 1.6"
1	=	pole ø 25 mm / 1.0"
1B	=	pole ø 30 mm / 1.2"
1F	=	pole ø 35 mm / 1.4"
1C	=	pole ø 38 mm / 1.5"
2F	=	horizontal rails 10 x 25, 8 x 35, 10 x 30, 10 x 50 mm
3	=	vertical rail 10 x 25 mm
4S	=	vertical wall channel
9	=	Löwenstein Medical / ITD / mounting channel
13	=	Mindray medical supply units
17	=	Amico pendants & headwalls
19	=	Dräger Ambia pendants & headwalls

How to create part numbers

4. Choose the colour requested for decorative parts (C):

- gr = RAL 7024 (graphite grey)
- bl = RAL 5013 (cobalt blue)

5. Choose the colour requested for the aluminium die-cast parts (D):

- 1 = RAL 9016 (traffic white)
- 2 = RAL 9002 (grey white)

6. Specify the spring depending on the weight of your monitor/ device - only with height adjustable arms (X):

- 24 = 0 - 3.5 kg / 0 - 7.7 lbs (only for MP2/ X2/ X3)
- 60 = 2 - 5 kg / 4.4 - 11 lbs
- 95 = 4 - 9 kg / 8.8 - 19.8 lbs
- 110 = 4.5 - 12.5 kg / 9.9 - 27.6 lbs
- 130 = 7.5 - 13 kg / 16.5 - 28.7 lbs
- 160 = 12.5 - 19 kg / 27.6 - 41.9 lbs
- 175 = 13 - 16 kg / 28.7 - 35.3 lbs
- 220 = 16 - 22 kg / 35.3 - 48.5 lbs

Example

01 Grounding	02 Arm version	03 Fixing	04 & 05 Colour	06 Spring tension
A	- 431PH	- Y	. CD	- X
A	- 431PH	- 4S	. gr1	- 95

General notes

Monitor adaptations

All mounting systems for **Philips IntelliVue series** are prepared to accept the Philips table top mount.

Mounting solutions for the **Efficia series** and **Sure Signs / Vital Signs** are shown in the catalogue “5” plunge plate adaptation”.

Please note!

The Philips table top mount must be ordered separately by Philips.

Components' grounding

All arms with integrated cable management are equipped with **component grounding**. No grounding is required for arms with external or semi-integrated cable management with cables not being led through joints.

Load capacity

All **height adjustable arms** have a load capacity of 22 kg / 48.5 lbs. Rear mounted monitor adaptations and horizontally mounted 5” plunge plates accept a maximum monitor weight of 18 kg / 39.7 lbs. An additional 4 kg / 8.8 lbs may be mounted on a down post underneath the front swivel part. Depending on material and tensile factor all weight indications have a 4-fold and/ or 6-fold safety factor according to IEC 60601-1 standards.

Custom-designed solutions and MRI applications

Please contact us for **custom-designed** solutions.

Product marking

All products which are classified as medical product risk class 1 are CE marked. As **medical product risk class 1** they are conform with the regulations (EU) 2017/745 (MDR) and IEC 60601-1. Other standards of the IEC 60601 series are not applicable to our products, regardless of their version.

MD A stand-alone product that is already classified as a medical product class 1 before being integrated into an overall medical device. The product is CE-marked. A declaration of conformity is available.

~~MD~~ Accessories or spare parts that have no independent function and are therefore not subject to the MDR. These products are not CE-marked. A declaration of conformity is not required.

Warranty

All CIM products have a 5-year warranty to be free of defects in material and functionality from the date of delivery.

How to find the right product for your needs?

No problem with our configurator

<https://cim-configurator.com>

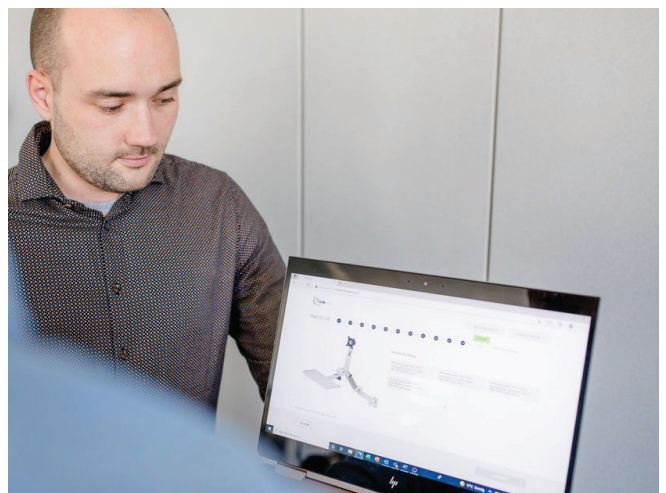

Product highlights

Non-height adjustable arm

Pivot and extended pivot arms offer **full cable integration** and easy cleaning for **infection control** in all critical care areas in the clinical environment. Our **5-years warranty** guarantees reliable, trouble-free and maintenance-free operation. The swivel function at the fixing point as well as the **tilt/ swivel function** of the monitor adaptation offers optimum positioning of your device. The extended pivot arm is a two-part arm with central pivot point between the two arm sections. All bottom-mounted monitors have the safety feature of a **20° tilt stop**.

Height adjustable arm

The height adjustable arm offers **full cable integration**, one-wipe clean surfaces and our **5-year warranty** on the entirety of the product. Vertically and horizontally adjustable, the arm offers optimal positioning of your device. A constant viewing angle when vertically adjusted is guaranteed by a parallel linkage. **Weight-optimized springs counter-balance** the monitor without making any adjustments. All bottom-mounted monitors have the safety feature of a **20° tilt stop**. Individual rotational stops may be integrated in any joint.

To provide the perfect combination of arm and monitor, the CIM articulated height adjustable arm has a simple quarter-turn lock to hold the arm safely in position when removing the monitor. Furthermore the arm is equipped with the unique safety feature of a slow-release gas spring. Should anybody try to remove the monitor before locking the arm in position, the arm will only rise at a slow and even tempo.



SAFETY