

# Extended pivot arm light duty cube

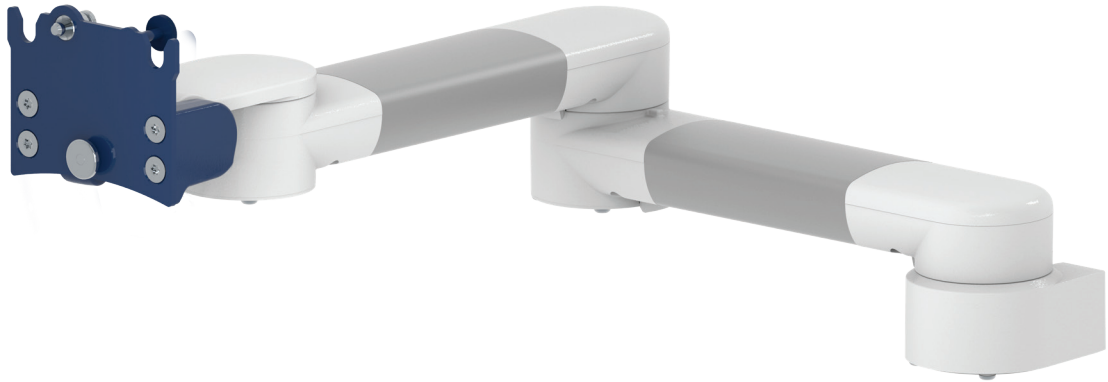

**Monitor adaption**

quick release base plate

**Colours to choose** **CD**

decorative parts RAL 5013 cobalt blue / RAL 7024 graphite grey  
 aluminum parts RAL 9016 traffic white / RAL 9002 grey white

**Max. load capacity support arm**

8 kg / 17.6 lbs

**Max. load monitor adaption**

8 kg / 17.6 lbs

**Product weight**

2.7 kg / 6.0 lbs

**Part number**

A-33030Q-**Y.CD**

Z-QR-C.D quick release adapter plate VESA 75

**Fixings** **Y**

details page 4



4S

Adapter for vertical wall channel



2F

Horizontal rail clamp

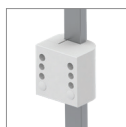

3

Vertical rail clamp



1V

Universal pole clamp



1  
1B  
1F  
1C

Fixed pole clamp



13

Adapter for Mindray medical supply units



17

Adapter for Amico pendants & headwalls



19

Adapter for Dräger Ambia pendants & headwalls

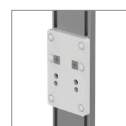

9

Adapter for Löwenstein Medical / ITD / mounting channel

# Extended pivot arm light duty qube

## Technical data

---

### SIDE VIEW

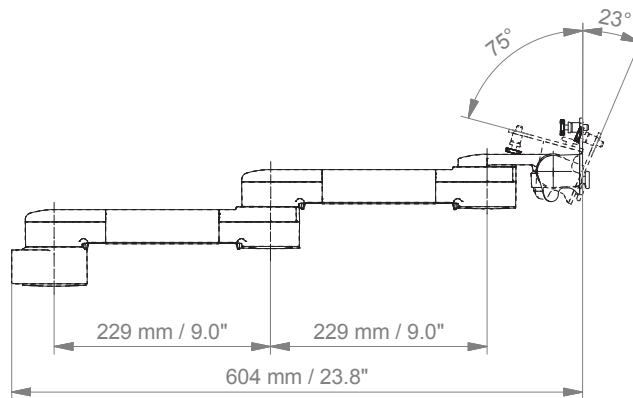

---

### TOP VIEW

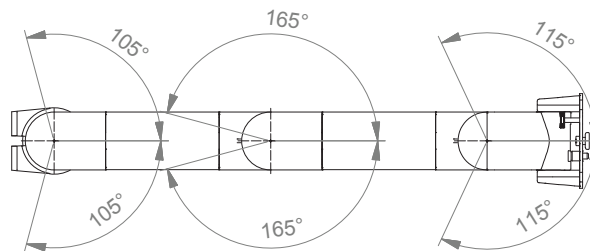

## Adapter plate

---

### VESA 75 Quick release adapter plate (Z-QR-C.D)









The adapter plate shown is mounted to the rear side of the monitor's hole pattern 75 x 75 mm (2.9 x 2.9"). The quick release adapter plate has to be ordered separately.

Product weight: 0.2 kg / 0.4 lbs

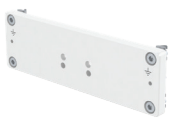

## Fixings Y



| Illustration  | Description                       | Notes  | Weight   | Part no.            |
|---|-----------------------------------|--|--|---------------------|
|    | Adapter for vertical wall channel | To mount to CIM wall channel (compatible with GCX channel)<br>Please order separately:<br>CIM wall channel, see catalogue accessoires  | 0.6 kg / 1.3 lbs   | 4S                  |
|   | Horizontal rail clamp             | To mount to horizontal European rails<br>10 x 25, 8 x 35, 10 x 30, 10 x 50 mm  | 1.1 kg / 2.4 lbs   | 2F                  |
|  | Vertical rail clamp               | To mount to vertical European rail 10 x 25 mm  | 0.5 kg / 1.1 lbs   | 3                   |
|  | Universal pole clamp              | V-block to mount to pole $\varnothing$ 23 - 40 mm / 0.9 - 1.6"   | 0.6 kg / 1.3 lbs   | 1V                  |
|  | Fixed pole clamp                  | To mount to pole $\varnothing$ 25 mm / 1.0"<br>To mount to pole $\varnothing$ 30 mm / 1.2"<br>To mount to pole $\varnothing$ 35 mm / 1.4"<br>To mount to pole $\varnothing$ 38 mm / 1.5" | 0.3 kg / 0.7 lbs<br>0.4 kg / 0.9 lbs<br>0.4 kg / 0.9 lbs<br>0.4 kg / 0.9 lbs | 1<br>1B<br>1F<br>1C |
|  | Adapter medical supply units      | For Mindray medical supply units   | 0.8 kg / 1.8 lbs   | 13                  |
|  | Adapter pendants & headwalls      | For Amico pendants & headwalls   | 0.6 kg / 1.3 lbs   | 17                  |
|  | Adapter pendants & headwalls      | For Dräger Ambia pendants & headwalls  | 0.6 kg / 1.3 lbs   | 19                  |
|  | Adapter pendants & headwalls      | For Löwenstein Medical / ITD / mounting channels   | 0.4 kg / 0.9 lbs   | 9                   |

# How to create part numbers

Part numbers can be easily created by following the steps below:

Please replace the letters in **green** with the part no. code as per your requirements.

## 1. Components' grounding:

|   |   |              |
|---|---|--------------|
| S | = | not grounded |
| A | = | grounded     |

## 2. Choose the arm version required:

|             |   |  |
|-------------|---|--|
| 910Q        | = | flush mount qube   |
| 224Q / 230Q | = | support arm pivot qube                                   |
| 224A / 230A | = | support arm pivot qube with docking station              |
| 33030Q      | = | extended pivot arm light duty qube                       |
| 33030A      | = | extended pivot arm light duty qube with docking station  |
| 431Q        | = | height adjustable arm qube                               |
| 431A        | = | height adjustable arm qube with docking station          |
| 73130Q      | = | extended height adjustable arm qube                      |
| 73130A      | = | extended height adjustable arm qube with docking station |

## 3. Specify where you want to mount the arm and select the fixing (Y):

|    |   |   |
|----|---|---|
| 1V | = | pole ø 23 - 40 mm / 0.9 - 1.6"                        |
| 1  | = | pole ø 25 mm / 1.0"                                   |
| 1B | = | pole ø 30 mm / 1.2"                                   |
| 1F | = | pole ø 35 mm / 1.4"                                   |
| 1C | = | pole ø 38 mm / 1.5"                                   |
| 2F | = | horizontal rails 10 x 25, 8 x 35, 10 x 30, 10 x 50 mm |
| 3  | = | vertical rail 10 x 25 mm                              |
| 4S | = | vertical wall channel                                 |
| 9  | = | Löwenstein Medical / ITD / mounting channel           |
| 13 | = | Mindray medical supply units                          |
| 17 | = | Amico pendants & headwalls                            |
| 19 | = | Dräger Ambia pendants & headwalls                     |

## How to create part numbers

---

### 4. Choose the colour requested for decorative parts (C):

gr = RAL 7024 (graphite grey)  
 bl = RAL 5013 (cobalt blue)

### 5. Choose the colour requested for the aluminium die-cast parts (D):

1 = RAL 9016 (traffic white)  
 2 = RAL 9002 (grey white)

### 6. Specify the spring depending on the weight of your monitor/ device - only with height adjustable arms (X):

95 = 4 - 9 kg / 8.8 - 19.8 lbs

## Example

| 01<br>Grounding |   | 02<br>Arm version |   | 03<br>Fixing |   | 04 & 05<br>Colour |   | 06<br>Spring tension |
|-----------------|---|-------------------|---|--------------|---|-------------------|---|----------------------|
| A               | - | 431Q              | - | Y            | . | CD                | - | X                    |
| A               | - | 431Q              | - | 4S           | . | gr1               | - | 95                   |

## General notes

---

### Monitor Adaptations

The quick release monitor adaptation with adapter plate for VESA 75/75 (part no. Z-QR-C.D) allows a quick change of the monitor. Please note that the quick release adapter plate has to be ordered separately.

The 5" plunge plate is used for bottom-mounted monitors. A monitor-specific adapter plate (part no. Z-AP-G), which is mounted underneath the monitor and slid into the 5" plunge plate, has to be ordered separately.

### Components' grounding

All arms with integrated cable management are equipped with **component grounding**. No grounding is required for arms with external or semi-integrated cable management with cables not being led through joints.

### Load capacity

All **height adjustable arms** have a load capacity of 22 kg / 48.5 lbs. Rear mounted monitor adaptations and horizontally mounted 5" plunge plates accept a maximum monitor weight of 18 kg / 39.7 lbs. An additional 4 kg / 8.8 lbs may be mounted on a down post underneath the front swivel part. Depending on material and tensile factor all weight indications have a 4-fold and/ or 6-fold safety factor according to IEC 60601-1 standards.

### Custom-designed solutions and MRI applications

Please contact us for **custom-designed** solutions.

### Product marking

All products which are classified as medical product risk class 1 are CE marked. As **medical product risk class 1** they are conform with the regulations (EU) 2017/745 (MDR) and IEC 60601-1. Other standards of the IEC 60601 series are not applicable to our products, regardless of their version.

**MD** A stand-alone product that is already classified as a medical product class 1 before being integrated into an overall medical device. The product is CE-marked. A declaration of conformity is available.

~~MD~~ Accessories or spare parts that have no independent function and are therefore not subject to the MDR. These products are not CE-marked. A declaration of conformity is not required.

### Warranty

All CIM products have a 5-year warranty to be free of defects in material and functionality from the date of delivery.

---

## How to find the right product for your needs?

No problem with our configurator

<https://cim-configurator.com>



## Product highlights

---

### Non-height adjustable arm

Pivot and extended pivot arms offer **full cable integration** and easy cleaning for **infection control** in all critical care areas in the clinical environment. Our **5-years warranty** guarantees reliable, trouble-free and maintenance-free operation. The swivel function at the fixing point as well as the **tilt/ swivel function** of the monitor adaptation offers optimum positioning of your device. The extended pivot arm is a two-part arm with central pivot point between the two arm sections. All bottom-mounted monitors have the safety feature of a **20° tilt stop**.

### Height adjustable arm

The height adjustable arm offers **full cable integration**, one-wipe clean surfaces and our **5-year warranty** on the entirety of the product. Vertically and horizontally adjustable, the arm offers optimal positioning of your device. A constant viewing angle when vertically adjusted is guaranteed by a parallel linkage. **Weight-optimized springs counter-balance** the monitor without making any adjustments. All bottom-mounted monitors have the safety feature of a **20° tilt stop**. Individual rotational stops may be integrated in any joint.

To provide the perfect combination of arm and monitor, the CIM articulated height adjustable arm has a simple quarter-turn lock to hold the arm safely in position when removing the monitor. Furthermore the arm is equipped with the unique safety feature of a slow-release gas spring. Should anybody try to remove the monitor before locking the arm in position, the arm will only rise at a slow and even tempo.

**SAFETY**