

# Extended height adjustable arm with ergonomic W-bracket

MD

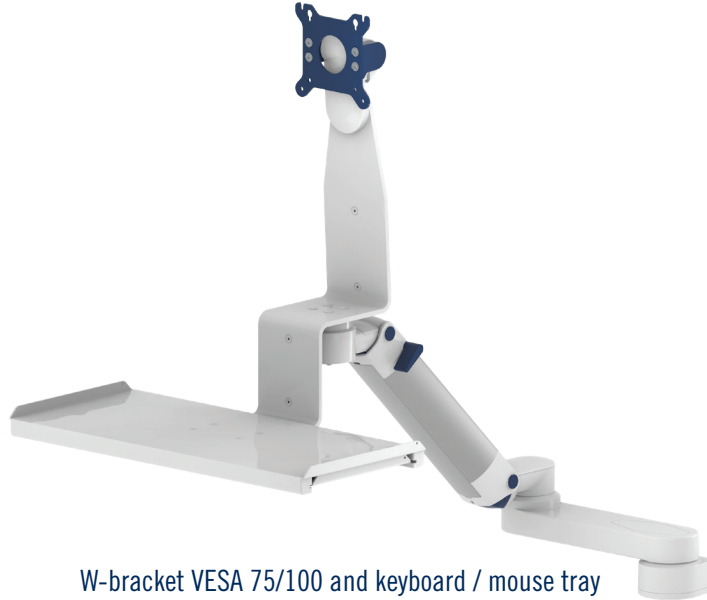

<b>Monitor adaption</b>	W-bracket VESA 75/100 and keyboard / mouse tray
<b>Height adjustment</b>	slow-flowing spring, parallel linkage for a constant viewing angle
<b>Colours to choose</b> <b>CD</b>	decorative parts RAL 5013 cobalt blue / RAL 7024 graphite grey aluminum parts RAL 9016 traffic white / RAL 9002 grey white
<b>Max. load capacity support arm</b>	18 kg / 39.7 lbs
<b>Max. load monitor adaptation</b>	18 kg / 39.7 lbs
<b>Product weight</b>	6.4 - 8.0 kg / 14.1 - 17.6 lbs (according to dimensions of keyboard tray)
<b>Balancing range</b> <b>X</b>	950 N (2.5 - 5.5 kg / 5.5 - 12.1 lbs); 1100 N (3.5 - 9.5 kg / 7.7 - 20.9 lbs); 1300 N (6 - 10 kg / 13.2 - 22 lbs); 1600 N (8 - 16 kg / 17.6 - 35.3 lbs); 1750 N (11 - 14 kg / 24.3 - 30.9 lbs); 2200 N (13 - 16 kg / 28.7 - 35.3 lbs)
<b>Keyboard tray</b> <b>T</b>	300 x 210 mm, 400 x 150 mm, 500 x 200 mm, 580 x 200 mm, 650 x 200 mm, 480 x 220 mm 11.8 x 8.3", 15.7 x 5.9", 19.7 x 7.9", 22.8 x 7.9", 25.6 x 7.9", 18.9 x 8.7"
<b>Part number</b>	A-73130F-Y.CD_X_T

## Fixings **Y**

details page 3



4S

Adapter for vertical wall channel



2F

Horizontal rail clamp

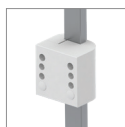

3

Vertical rail clamp



1V

Universal pole clamp



1  
1B  
1F  
1C

Fixed pole clamp



13

Adapter for Mindray medical supply units



17

Adapter for Amico pendants & headwalls



19

Adapter for Dräger Ambia pendants & headwalls

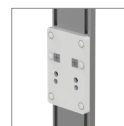

9

Adapter for Löwenstein Medical / ITD / mounting channel

# Extended height adjustable arm with ergonomic W-bracket

Technical data - keyboard tray 500 x 200 mm / 19.7 x 7.9"

## SIDE VIEW

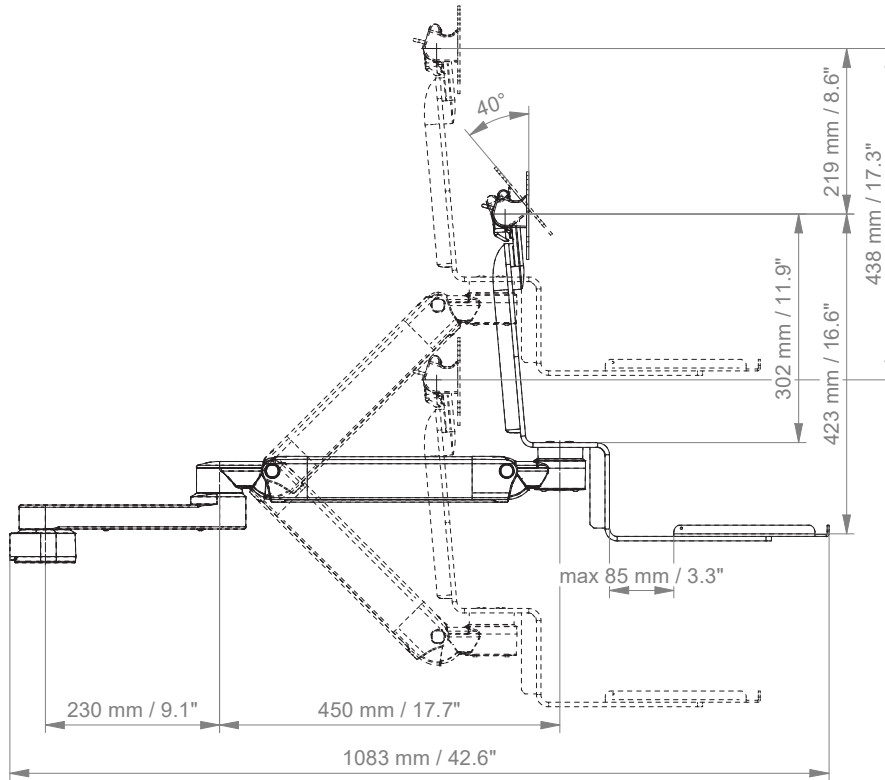



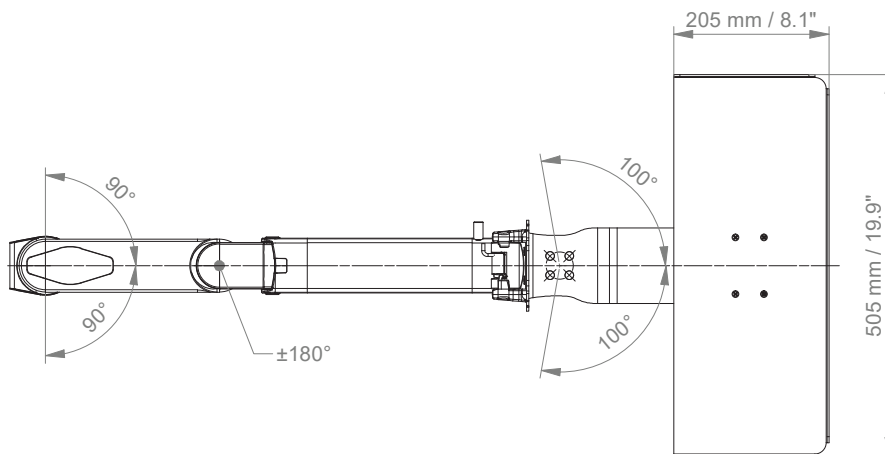





## TOP VIEW

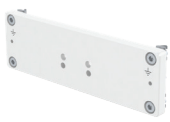

## Fixings Y



Illustration	Description	Notes	Weight	Part no.
	Adapter for vertical wall channel	To mount to CIM wall channel (compatible with GCX channel) Please order separately: CIM wall channel, see catalogue accessoires	0.6 kg / 1.3 lbs	4S
	Horizontal rail clamp	To mount to horizontal European rails 10 x 25, 8 x 35, 10 x 30, 10 x 50 mm	1.1 kg / 2.4 lbs	2F
	Vertical rail clamp	To mount to vertical European rail 10 x 25 mm	0.5 kg / 1.1 lbs	3
	Universal pole clamp	V-block to mount to pole $\varnothing$ 23 - 40 mm / 0.9 - 1.6"	0.6 kg / 1.3 lbs	1V
	Fixed pole clamp	To mount to pole $\varnothing$ 25 mm / 1.0" To mount to pole $\varnothing$ 30 mm / 1.2" To mount to pole $\varnothing$ 35 mm / 1.4" To mount to pole $\varnothing$ 38 mm / 1.5"	0.3 kg / 0.7 lbs 0.4 kg / 0.9 lbs 0.4 kg / 0.9 lbs 0.4 kg / 0.9 lbs	1 1B 1F 1C
	Adapter medical supply units	For Mindray medical supply units	0.8 kg / 1.8 lbs	13
	Adapter pendants & headwalls	For Amico pendants & headwalls	0.6 kg / 1.3 lbs	17
	Adapter pendants & headwalls	For Dräger Ambia pendants & headwalls	0.6 kg / 1.3 lbs	19
	Adapter pendants & headwalls	For Löwenstein Medical / ITD / mounting channels	0.4 kg / 0.9 lbs	9

# How to create part numbers

Part numbers can be easily created by following the steps below:

Please replace the letters in **green** with the part no. code as per your requirements.

## 1. Components' grounding:

A = grounded

## 2. Choose the arm version required:

224F / 230F / 224M / 230M = support arm pivot  
 H33030F / H33030M = extended pivot arm heavy duty  
 431F / 431M = height adjustable arm  
 73130F / 73130M = extended height adjustable arm

## 3. Specify where you want to mount the arm and select the fixing (Y):

1V = pole ø 23 - 40 mm / 0.9 - 1.6"  
 1 = pole ø 25 mm / 1.0"  
 1B = pole ø 30 mm / 1.2"  
 1F = pole ø 35 mm / 1.4"  
 1C = pole ø 38 mm / 1.5"  
 2F = horizontal rails 10 x 25, 8 x 35, 10 x 30, 10 x 50 mm  
 3 = vertical rail 10 x 25 mm  
 4S = vertical wall channel  
 9 = Löwenstein Medical / ITD / mounting channel  
 13 = Mindray medical supply units  
 17 = Amico pendants & headwalls  
 19 = Dräger Ambia pendants & headwalls

## 4. Choose the colour requested for decorative parts (C):

gr = RAL 7024 (graphite grey)  
 bl = RAL 5013 (cobalt blue)

## 5. Choose the colour requested for the aluminium die-cast parts (D):

1 = RAL 9016 (traffic white)  
 2 = RAL 9002 (grey white)

## How to create part numbers

### 6. Specify the spring depending on the weight of your monitor/ device - only with height adjustable arms (X):

Please note that the weight range of the individual springs may vary depending on the bracket (X).

#### Pneumatic Springs Explained:

The weight ranges of the pneumatic springs shown in our catalogues relate to the minimum and maximum weights of the products that can be added to the arm, for a perfectly balanced solution. The weight ranges can vary with the same pneumatic springs, as the overall weights placed on the front of the arms have to be considered. The total weight not only reflects the actual monitor weight, but also includes monitor adaptations, brackets and/ or trays. When choosing the pneumatic spring, please consider the weight of your monitor/ device only.

#### W-Bracket

95	=	2.5 - 5.5 kg / 5.5 - 12.1 lbs
110	=	3.5 - 9.5 kg / 7.7 - 20.9 lbs
130	=	6 - 10 kg / 13.2 - 22 lbs
160	=	8 - 16 kg / 17.6 - 35.3 lbs
175	=	11 - 14 kg / 24.3 - 30.9 lbs
220	=	13 - 16 kg / 28.7 - 35.3 lbs

#### Z-Bracket

95	=	1.5 - 4.5 kg / 3.3 - 9.9 lbs
110	=	3 - 9 kg / 6.6 - 19.8 lbs
130	=	5 - 9 kg / 11 - 19.8 lbs
160	=	8 - 15 kg / 17.6 - 33.1 lbs
175	=	10 - 13 kg / 22 - 28.7 lbs
220	=	13.5 - 16.5 kg / 29.8 - 36.4 lbs

### 7. Specify the requested size of the keyboard tray and mouse (T):

Standard	Magnetic	With wrist rest		Dimensions
30	30S		=	300 x 210 mm / 11.8 x 8.3"
40	40S		=	400 x 150 mm / 15.7 x 5.9"
50	50S	50W	=	500 x 200 mm / 19.7 x 7.9"
58	58S	58W	=	580 x 200 mm / 22.8 x 7.9"
65	65S	65W	=	650 x 200 mm / 25.6 x 7.9"
RC			=	480 x 220 mm (retractable mouse tray left/right 226 mm / 8.9")

## Example

01 Grounding	02 Arm version	03 Fixing	04 & 05 Colour	06 Spring tension	07 Keyboard tray
A	- 431F	- Y	. CD	- X	- T
A	- 431F	- 4S	. gr1	- 95	- 30

## General notes

---

### Monitor adaptations

The monitor adaptation VESA 75/100 is provided with a spring for counter-balance.

### Components' grounding

All arms with integrated cable management are equipped with **component grounding**. No grounding is required for arms with external or semi-integrated cable management with cables not being led through joints.

### Load capacity

All **height adjustable arms** have a load capacity of 22 kg / 48.5 lbs. Rear mounted monitor adaptations and horizontally mounted 5" plunge plates accept a maximum monitor weight of 18 kg / 39.7 lbs. An additional 4 kg / 8.8 lbs may be mounted on a down post underneath the front swivel part. Depending on material and tensile factor all weight indications have a 4-fold and/ or 6-fold safety factor according to IEC 60601-1 standards.

### Custom-designed solutions and MRI applications

Please contact us for **custom-designed** solutions.

### Product marking

All products which are classified as medical product risk class 1 are CE marked. As **medical product risk class 1** they are conform with the regulations (EU) 2017/745 (MDR) and IEC 60601-1. Other standards of the IEC 60601 series are not applicable to our products, regardless of their version.

**MD** A stand-alone product that is already classified as a medical product class 1 before being integrated into an overall medical device. The product is CE-marked. A declaration of conformity is available.

~~MD~~ Accessories or spare parts that have no independent function and are therefore not subject to the MDR. These products are not CE-marked. A declaration of conformity is not required.

### Warranty

All CIM products have a 5-year warranty to be free of defects in material and functionality from the date of delivery.

---

## How to find the right product for your needs?

No problem with our configurator

<https://cim-configurator.com>



## Product highlights

---

### Non-height adjustable arm

Pivot and extended pivot arms offer **full cable integration** and easy cleaning for **infection control** in all critical care areas in the clinical environment. Our **5-years warranty** guarantees reliable, trouble-free and maintenance-free operation. The swivel function at the fixing point as well as the **tilt/ swivel function** of the monitor adaptation offers optimum positioning of your device. The extended pivot arm is a two-part arm with central pivot point between the two arm sections. All bottom-mounted monitors have the safety feature of a **20° tilt stop**.

### Height adjustable arm

The height adjustable arm offers **full cable integration**, one-wipe clean surfaces and our **5-year warranty** on the entirety of the product. Vertically and horizontally adjustable, the arm offers optimal positioning of your device. A constant viewing angle when vertically adjusted is guaranteed by a parallel linkage. **Weight-optimized springs counter-balance** the monitor without making any adjustments. All bottom-mounted monitors have the safety feature of a **20° tilt stop**. Individual rotational stops may be integrated in any joint.

To provide the perfect combination of arm and monitor, the CIM articulated height adjustable arm has a simple quarter-turn lock to hold the arm safely in position when removing the monitor. Furthermore the arm is equipped with the unique safety feature of a slow-release gas spring. Should anybody try to remove the monitor before locking the arm in position, the arm will only rise at a slow and even tempo.

**SAFETY**