

MOUNTING REFERENCE GUIDE

# Accessories

CIM Cable Integrated Mounting System



THINK BEFORE  
YOU PRINT



# Content

---

<b>General notes</b>	<b>3</b>
<b>How to create part numbers</b>	<b>4</b>
<b>Drawer</b>	<b>5</b>
<b>Infusion Pump Mount</b>	<b>7</b>
<b>Fixings for Drawers and Infusion Pump Mounts</b>	<b>12</b>
<b>Basket</b>	<b>13</b>
<b>Fixings for Baskets</b>	<b>14</b>
<b>Table Column / Floor Column</b>	<b>15</b>
<b>Cable Management</b>	<b>17</b>
<b>Fixings for Cable Hooks</b>	<b>18</b>
<b>Q-Fit</b>	<b>19</b>
<b>CPU Clamp and Universal Clamp</b>	<b>20</b>
<b>Fixings for CPU Clamps and Universal Clamps</b>	<b>21</b>
<b>Power Supply Holster</b>	<b>22</b>
<b>Fixings for Power Supply Holster</b>	<b>23</b>
<b>Wall Channel and European Rail</b>	<b>24</b>
<b>Keyboard Tray</b>	<b>25</b>
<b>Fixings for Keyboard Trays</b>	<b>26</b>
<b>Handle</b>	<b>27</b>
<b>Down Post</b>	<b>29</b>
<b>Miscellaneous</b>	<b>30</b>
<b>Fixings for Holder Barcode Scanner</b>	<b>31</b>

## General notes

---

### Custom-designed solutions and MRI applications

Please contact us for **custom-designed** solutions.

### Product marking

All products which are classified as medical product risk class 1 are CE marked. As **medical product risk class 1** they are conform with the regulations (EU) 2017/745 (MDR) and IEC 60601-1. Other standards of the IEC 60601 series are not applicable to our products, regardless of their version.

**MD** A stand-alone product that is already classified as a medical product class 1 before being integrated into an overall medical device. The product is CE-marked. A declaration of conformity is available.

~~MD~~ Accessories or spare parts that have no independent function and are therefore not subject to the MDR. These products are not CE-marked. A declaration of conformity is not required.

### Warranty

All CIM products have a 5-year warranty to be free of defects in material and functionality from the date of delivery.

---

## How to find the right product for your needs?

No problem with our configurator

<https://cim-configurator.com>



# How to create part numbers

Part numbers can be easily created by following the steps below:

Please replace the letters in **green** with the part no. code as per your requirements.

## 1. Specify where you want to mount the arm and select the fixing (Y):

1V	=	pole ø 23 - 40 mm / 0.9 - 1.6"
1	=	pole ø 25 mm / 1.0"
1B	=	pole ø 30 mm / 1.2"
1F	=	pole ø 35 mm / 1.4"
1C	=	pole ø 38 mm / 1.5"
2F	=	horizontal rails 10 x 25, 8 x 35, 10 x 30, 10 x 50 mm
3	=	vertical rail 10 x 25 mm
4S	=	vertical wall channel
4V	=	vertical wall channel (only for drawers)
4Z	=	vertical wall channel (only for accessories, not for support arms)
5	=	horizontal rails 10 x 25, 8 x 35, 10 x 30 mm
6H / 6R	=	horizontal rails 10 x 25, 8 x 35, 10 x 30, 10 x 50 mm
6V	=	vertical rails 10 x 25, 8 x 35, 10 x 30, 10 x 50 mm
19	=	Dräger Ambia pendants & headwalls
70	=	non-height adjustable arms
71	=	height adjustable arms

## 2. Choose the colour requested for decorative parts (C):

gr	=	RAL 7024 (graphite grey)
bl	=	RAL 5013 (cobalt blue)
w	=	RAL 9016 (traffic white) only for drawers, wall channels and handle for carts

## 3. Choose the colour requested for the aluminium die-cast parts (D):

1	=	RAL 9016 (traffic white)
2	=	RAL 9002 (grey white)

## Example

Area of application		Typ of accessory		01 Fixing		02 & 03 Colour		04 Keyboard Tray
Z	-	EF	-	Y	.	CD	-	T
Z	-	EF	-	4S	.	bl1	-	50S

# Drawer

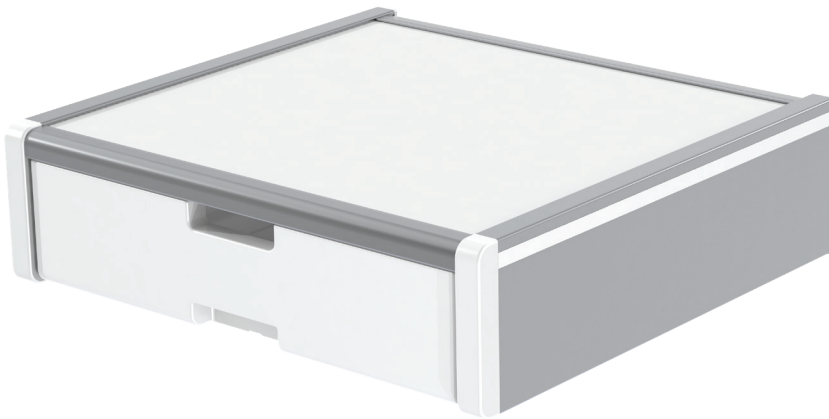

<b>Dimensions</b>	440 x 413 x 120 mm / 17.3 x 16.3 x 4.7" (W x D x H)
<b>Drawer dimensions</b>	375 x 335 x 85 mm / 14.8 x 13.2 x 3.3" (W x D x H)
<b>Material</b>	Aluminium, HPL (high pressure laminate), ABS
<b>Surface</b>	Anodized, HPL and ABS (= scratch-proof, resistant against impact and disinfectants)
<b>Colour</b>	RAL 9016 traffic white
<b>Max. load capacity</b>	25 kg / 55.1 lbs (4-fold safety)
<b>Drawer max. weight</b>	5 kg / 11 lbs
<b>Product weight</b>	7.1 kg / 15.6 lbs 7.4 kg / 16.3 lbs (with laterally rails)
<b>Part number</b>	Z-SLK-Y.w Z-SLK-NS-Y.w with (2) laterally rails 25 x 10 x 350 mm

## Fixings Y

details page 12

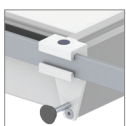

2F

Horizontal rail clamp

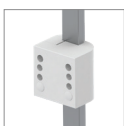

3

Vertical rail clamp



4V

Adapter for vertical wall channel



1V

Universal pole clamp

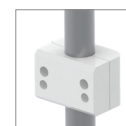

1

IB

1F

1C

Fixed pole clamp

# Drawer

## Technical data

---

### SIDE VIEW

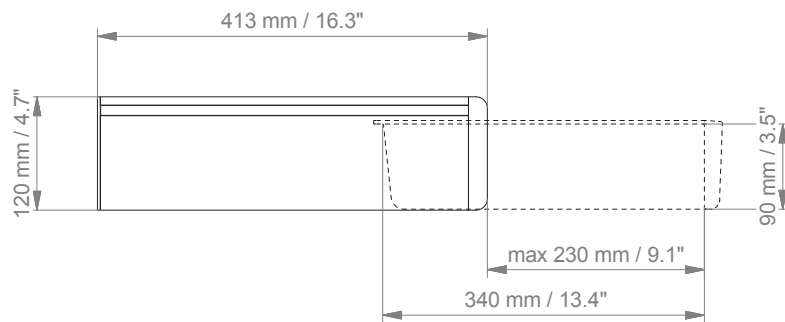

### TOP VIEW

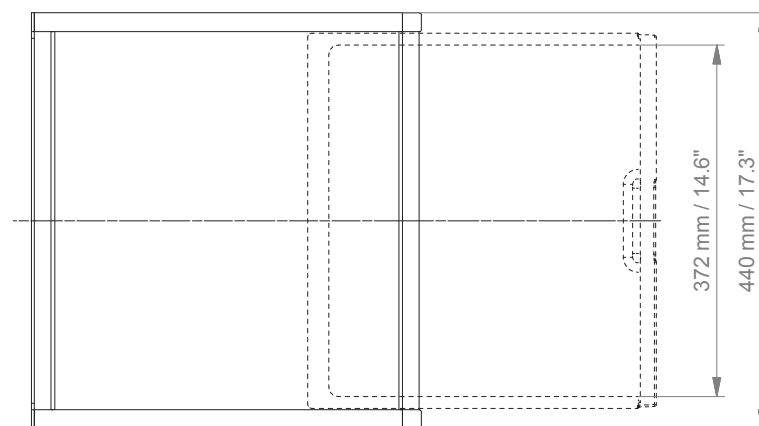

# Infusion pump mount - pivot arm

**MD**



**Colours to choose** **D**

Aluminium parts: RAL 9016 traffic white (1) / RAL 9002 grey white (2)

**Maximum weight**

16.5 kg / 36.4 lbs; 23 kg / 50.1 lbs; 30 kg / 66.1 lbs (6-fold safety)

**Front pole clamp**

ø 25 mm / 1"

**Part number**

Part number	Part number	Armtime	Arm length	Maximum weight	Product weight
Z-224RR-Y.D	240	261 mm / 10.3"	30 kg / 66.1 lbs	1.2 kg / 2.6 lbs	
Z-230RR-Y.D	300	321 mm / 12.6"	23 kg / 50.7 lbs	1.3 kg / 2.9 lbs	
Z-240RR-Y.D	400	421 mm / 16.5"	16.5 kg / 36.4 lbs	1.5 kg / 3.3 lbs	

**Fixings** **Y**

details page 12



2F

Horizontal rail clamp



3

Vertical rail clamp



4S

Adapter for vertical wall channel



1V

Universal pole clamp



1

1B

1F

1C

Fixed pole clamp



19

Adapter for Dräger Ambia pendants & headwalls

# Infusion pump mount - pivot arm

Technical data - arm type 240

---

SIDE VIEW

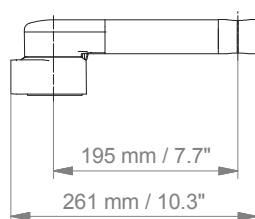

TOP VIEW

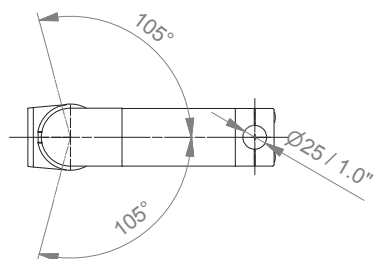



# Infusion pump mount - extended pivot arm heavy duty

MD



**Colours to choose** D

Aluminium parts: RAL 9016 pure white (1) / RAL 9002 grey white (2)

**Maximum weight**

23 kg / 50.7 lbs (6-fold safety)

**Product weight**

2.5 kg / 5.5 lbs

**Front pole clamp**

ø 25 mm / 1"

**Part number**

Z-H33030RR-Y.D

The combination of two or more extended pivot arms with an IV pole is not permitted.

**Fixings** Y

details page 12



2F

Horizontal rail clamp

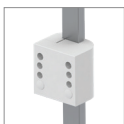

3

Vertical rail clamp



4S

Adapter for vertical wall channel



1V

Universal pole clamp

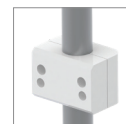

1

1B

1F

1C

Fixed pole clamp



19

Adapter for Dräger Ambia pendants & headwalls

# Infusion pump mount - extended pivot arm heavy duty

## Technical data

---

### SIDE VIEW

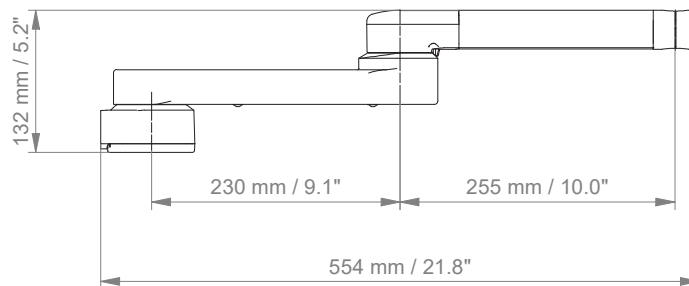

### TOP VIEW

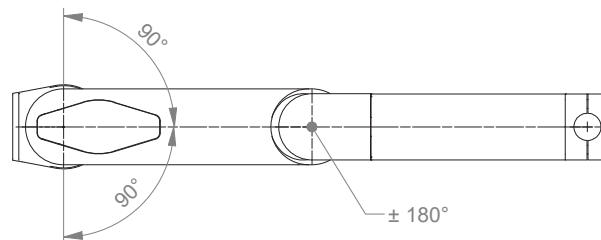

# Infusion pump mount - accessories

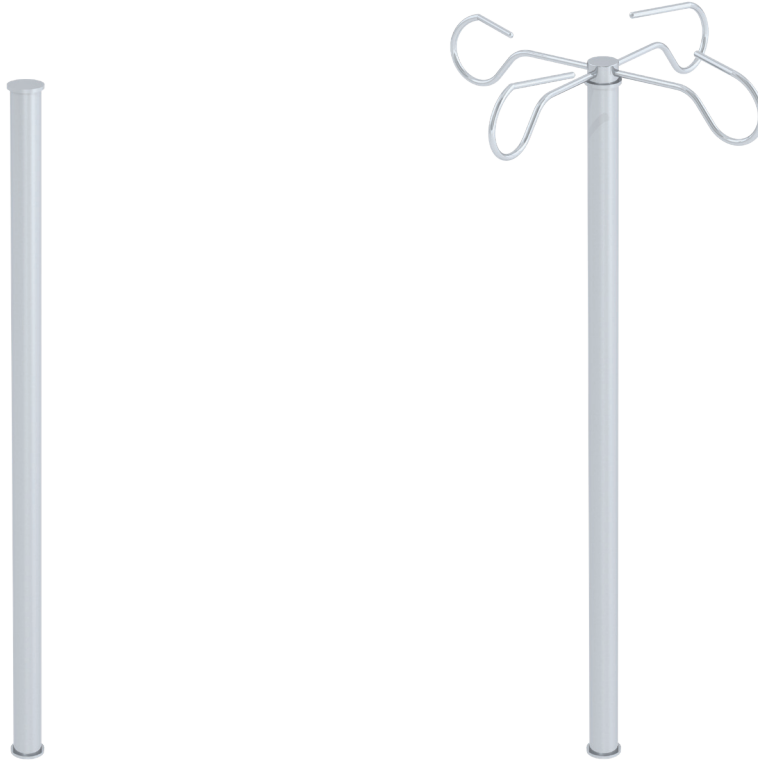

**Material**

Stainless steel

**Part number**

Infusion pole ø 25 mm / 1"

Part number	Length	Product weight
Z-IF_600	600 mm / 23.6"	0.7 kg / 1.5 lbs
Z-IF_1200	1200 mm / 47.2"	1.3 kg / 2.9 lbs

Infusion pole ø 25 mm / 1" with infusion bag hooks

Part number	Length	Product weight
Z-IF6_600	600 mm / 23.6"	0.9 kg / 2.0 lbs
Z-IF6_1200	1200 mm / 47.2"	1.5 kg / 3.3 lbs

## Fixings Y

### for drawers and infusion pump mount

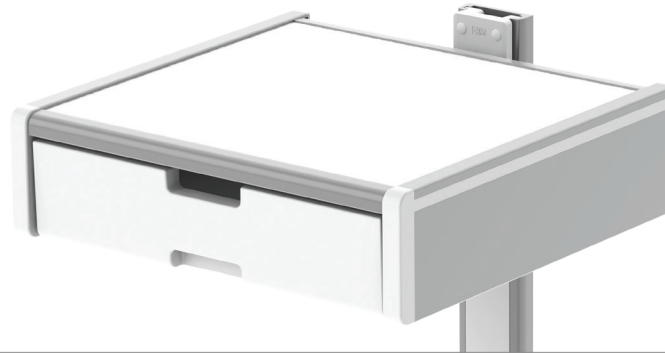







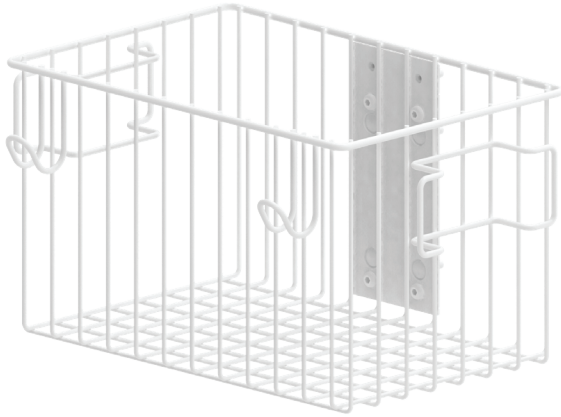

Illustration	Description	Notes	Weight	Part no.
	Horizontal rail clamp	To mount to horizontal European rails 10 x 25, 8 x 35, 10 x 30, 10 x 50 mm	1.1 kg / 2.4 lbs	2F
	Vertical rail clamp	To mount to vertical European rail 10 x 25 mm	0.5 kg / 1.1 lbs	3
	Adapter for vertical wall channel	To mount to CIM wall channel (compatible with GCX channel) only for drawers	0.4 kg / 0.9 lbs	4V
	Adapter for vertical wall channel	To mount to CIM wall channel (compatible with GCX channel)	0.6 kg / 1.3 lbs	4S
	Universal pole clamp	V-block to mount to pole $\varnothing$ 23 - 40 mm / 0.9 - 1.6"	0.6 kg / 1.3 lbs	1V
	Fixed pole clamp	To mount to pole $\varnothing$ 25 mm / 1.0" To mount to pole $\varnothing$ 30 mm / 1.2" To mount to pole $\varnothing$ 35 mm / 1.4" To mount to pole $\varnothing$ 38 mm / 1.5"	0.3 kg / 0.7 lbs 0.4 kg / 0.9 lbs 0.4 kg / 0.9 lbs 0.4 kg / 0.9 lbs	1 1B 1F 1C
	Adapter pendants & headwalls	For Dräger Ambia pendants & headwalls	0.6 kg / 1.3 lbs	19

# Basket



**Dimensions (W x D x H)**

**Basket big**

300 x 200 x 180 mm / 11.8 x 7.9 x 7.1"

**Basket small**

200 x 150 x 100 mm / 7.9 x 5.9 x 3.9"

**Maximum load**  
**Product weight**

10 kg / 22 lbs  
1.1 kg / 2.4 lbs

2.5 kg / 5.5 lbs  
0.6 kg / 1.3 lbs

**Part number**

Z-51-Y.1

Z-52-Y.1

**Fixings Y**

details page 14

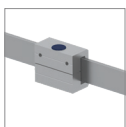

6H  
6R

Horizontal rail clamp

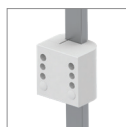

3

Vertical rail clamp



4Z

Adapter for vertical wall channel



1V

Universal pole clamp

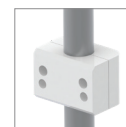

1  
1B  
1F  
1C

Fixed pole clamp



70

Bracket with swivel function









71

Bracket with swivel function

## Fixings Y for baskets



Illustration	Description	Notes	Weight	Part no.
	Horizontal rail clamp	To mount to horizontal rail 10 x 25, 8 x 35, 10 x 30, 10 x 50 mm With locking, to mount to horizontal rail 10 x 25, 8 x 35, 10 x 30, 10 x 50 mm	0.2 kg / 0.4 lbs 0.2 kg / 0.4 lbs	6H 6R
	Vertical rail clamp	To mount to vertical European rail 10 x 25 mm	0.5 kg / 1.1 lbs	3
	Adapter for vertical wall channel	To mount to CIM wall channel (compatible with GCX channel)	0.2 kg / 0.4 lbs	4Z
	Universal pole clamp	V-block to mount to pole ø 23 - 40 mm / 0.9 - 1.6"	0.6 kg / 1.3 lbs	1V
	Fixed pole clamp	To mount to pole ø 25 mm / 1.0" To mount to pole ø 30 mm / 1.2" To mount to pole ø 35 mm / 1.4" To mount to pole ø 38 mm / 1.5"	0.3 kg / 0.7 lbs 0.4 kg / 0.9 lbs 0.4 kg / 0.9 lbs 0.4 kg / 0.9 lbs	1 1B 1F 1C
	Bracket for basket with swivel function	To mount to non-height adjustable arms	0.3 kg / 0.7 lbs	70
	Bracket for basket with swivel function	To mount to height adjustable arms	0.3 kg / 0.7 lbs	71

# Table column / floor column

**MD**



The column profile can be mounted to table or floor. The opposite C-profiles are intended to accept all CIM arms and/ or CIM components.

Besides the standard length of the column indicated below, individually required lengths are available on request.

<b>Table column</b>	L 800 mm/ 31.5"
<b>Floor plate</b>	150 x 150 mm / 5.9 x 5.9", hole pattern 126 x 126 mm / 5 x 5"
<b>Product weight</b>	2.9 kg / 6.4 lbs
<b>Part number</b>	T-CTP-60.w1_800

# Table column / floor column

## Technical data

### TOP VIEW

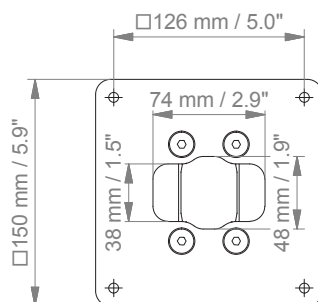

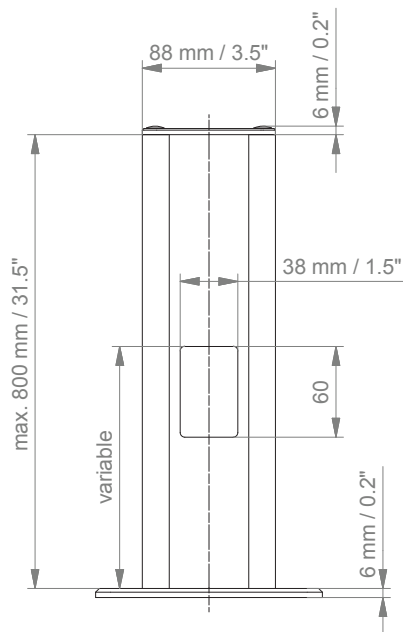

### SIDE VIEW





## Cable Management - Cable hook







Illustration	Description	Fixing	Weight	Part no.
	<b>Dual cable hook</b> To mount to front joint of arm	To mount to non-height adjustable arms  To mount to height adjustable arms	0.4 kg / 0.9 lbs 0.4 kg / 0.9 lbs	Z-KH2-70.1  Z-KH2-71.1
	<b>Dual cable hook</b>	Details page 18	0.4 kg / 0.9 lbs	Z-KH2-Y.1
	<b>Triple cable hook</b> To mount to front joint of arm	To mount to non-height adjustable arms  To mount to height adjustable arms	0.5 kg / 1.1 lbs 0.5 kg / 1.1 lbs	Z-KH3-70.1  Z-KH3-71.1
	<b>Triple cable hook</b>	Details page 18	0.6 kg / 1.3 lbs	Z-KH3-Y.1
	<b>Down post with cable hook</b> To mount to front joint of arm	To mount to non-height adjustable arms Length 150 mm / 5.9" Length 300 mm / 11.8"  To mount to height adjustable arms Length 150 mm / 5.9" Length 300 mm / 11.8"	0.3 kg / 0.7 lbs 0.4 kg / 0.9 lbs  0.3 kg / 0.7 lbs 0.4 kg / 0.9 lbs	Z-KH6-70.1_150 Z-KH6-70.1_300  Z-KH6-71.1_150 Z-KH6-71.1_300

## Fixings Y

### for cable hooks



Illustration	Description	Notes	Weight	Part no.
	Horizontal rail clamp	To mount to horizontal rail 10 x 25, 8 x 35, 10 x 30, 10 x 50 mm With locking, to mount to horizontal rail 10 x 25, 8 x 35, 10 x 30, 10 x 50 mm	0.2 kg / 0.4 lbs 0.2 kg / 0.4 lbs	6H 6R
	Vertical rail clamp	To mount to vertical European rail 10 x 25 mm	0.5 kg / 1.1 lbs	3
	Adapter for vertical wall channel	To mount to CIM wall channel (compatible with GCX channel)	0.1 kg / 0.2 lbs	4Z
	Universal pole clamp	V-block to mount to poles ø 23 - 40 mm / ø 0.9 - 1.6"	0.6 kg / 1.3 lbs	1V
	Fixed pole clamp	To mount to pole ø 25 mm / ø 1" To mount to pole ø 30 mm / ø 1.2" To mount to pole ø 35 mm / ø 1.4" To mount to pole ø 38 mm / ø 1.5"	0.3 kg / 0.7 lbs 0.4 kg / 0.9 lbs 0.4 kg / 0.9 lbs 0.4 kg / 0.9 lbs	1 1B 1F 1C

# Cable management

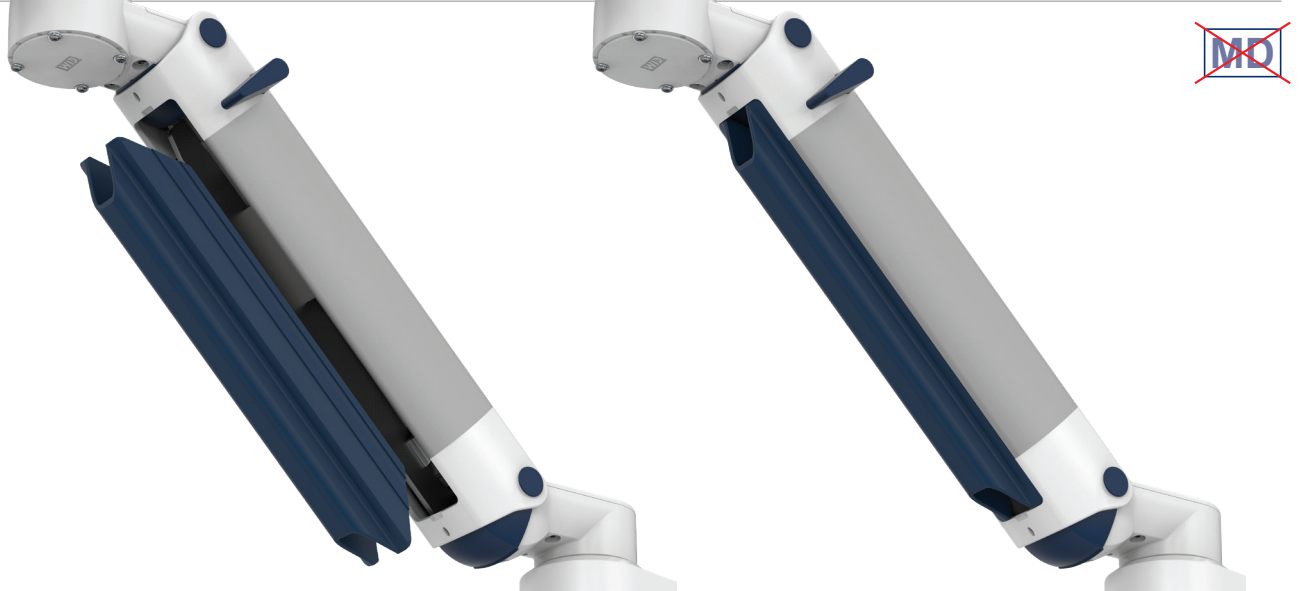
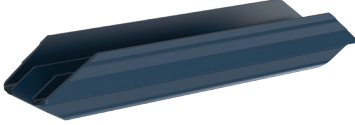





Illustration	Description	Notes	Weight	Part no.
	<b>Q-Fit</b>	Cover profile for height adjustable arms Cover profile for height adjustable arms, part is ordered together with the support arm.  Colours to choose: (C): RAL 7024 graphite grey (gr) or RAL 5013 cobalt blue (bl)	0.1 kg / 0.2 lbs 0.1 kg / 0.2 lbs	Z-QFIT.C O-QFIT.C
	<b>Q-Fit</b>	Cover profile for extension Cover profile for extension, part is ordered together with the support arm.	0.1 kg / 0.2 lbs 0.1 kg / 0.2 lbs	Z-QFIT.EXT O-QFIT.EXT
	<b>Cable clip</b>	For down post $\varnothing$ 25 mm, L 100 mm / $\varnothing$ 1", L 3.9"  Colours to choose: (C): RAL 7024 graphite grey (gr) or RAL 5013 cobalt blue (bl)	0.1 kg / 0.2 lbs	Z-KC-1.C

## CPU clamp and universal clamp



Illustration	Description	Notes	Weight	Part no.
	<p><b>CPU dual clamp set</b></p> <p>Existing of: 2 clamps (top and bottom) 2 fixings for vertical wall channel</p> <p>Colour to choose (D): RAL 9016 traffic white (1) or RAL 9002 grey white (2)</p>	<p>CPU width</p> <p>27 - 45 mm / 1.1 - 1.8" 45 - 70 mm / 1.8 - 2.8" 60 - 100 mm / 2.4 - 3.9" 85 - 150 mm / 3.3 - 5.9"</p> <p>With extension plate</p> <p>130 - 170 mm / 5.1 - 6.7" 170 - 215 mm / 6.7 - 8.5"</p>	<p>0.3 kg / 0.7 lbs 0.4 kg / 0.9 lbs 0.4 kg / 0.9 lbs 0.5 kg / 1.1 lbs 0.6 kg / 1.3 lbs 0.7 kg / 1.5 lbs</p>	<p>Z-CPU-4.D_27 Z-CPU-4.D_45 Z-CPU-4.D_60 Z-CPU-4.D_85 Z-CPU-4.D_130 Z-CPU-4.D_170</p>
	<p><b>Universal clamp</b></p> <p>Adjustable from 35 - 57 mm / 1.4 - 2.3" 48 - 63 mm / 1.9 - 2.5"</p> <p>Colour to choose (D): RAL 9016 traffic white (1) or RAL 9002 grey white (2)</p>	<p>Details page 21</p>	<p>0.2 kg / 0.4 lbs 0.2 kg / 0.4 lbs</p>	<p>Z-UK-Y.D_35 Z-UK-Y.D_48</p>

# Fixings Y

## for universal clamps

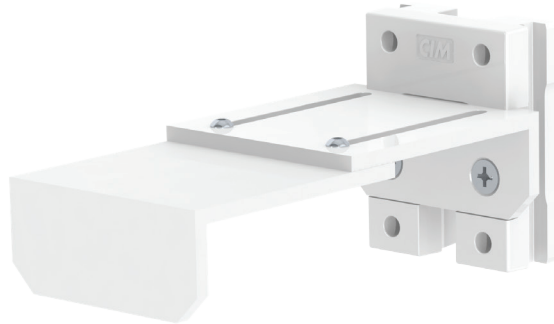





Illustration	Description	Notes	Weight	Part no.
	Universal pole clamp	V-block to mount to poles $\varnothing$ 23 - 40 mm / $\varnothing$ 0.9 - 1.6"	0.6 kg / 1.3 lbs	1V
	Horizontal rail clamp	To mount to horizontal rail 10 x 25, 8 x 35, 10 x 30, 10 x 50 mm With locking, to mount to horizontal rail 10 x 25, 8 x 35, 10 x 30, 10 x 50 mm	0.2 kg / 0.4 lbs 0.2 kg / 0.4 lbs	6H 6R
	Adapter for wall channel	To mount to vertical CIM wall channel (compatible with GCX channel)	0.1 kg / 0.2 lbs	4Z

# Power supply holster







Illustration	Description	Notes	Weight	Part no.
	<p><b>Power supply enclosure</b></p> <p>Double 255 x 115 x 85 mm Double 10 x 4.5 x 3.4"</p> <p>Triple 255 x 165 x 85 mm Triple 10 x 6.5 x 3.4" (Dimensions H x W x D)</p>	<p>Details page 23</p>	<p>1.0 kg / 2.2 lbs</p> <p>1.3 kg / 2.9 lbs</p>	<p>Z-PS2-Y.1</p> <p>Z-PS3-Y.1</p>
	<p><b>Power supply holster</b></p> <p>143 x 126 x 48 mm 5.6 x 5 x 1.9" (Dimensions H x W x D)</p> <p>Universal power supply holster for different sizes</p>	<p>Details page 23</p>	<p>0.6 kg / 1.3 lbs</p>	<p>Z-NH-Y.1</p>

# Fixings Y

## for power supply holster



Illustration	Description	Notes	Weight	Part no.
	Horizontal rail clamp	To mount to horizontal rail 10 x 25, 8 x 35, 10 x 30, 10 x 50 mm	0.2 kg / 0.4 lbs	6H
	Vertical rail clamp	To mount to vertical rail 10 x 25, 8 x 35, 10 x 30, 10 x 50 mm	0.2 kg / 0.4 lbs	6V
	Adapter for vertical wall channel	To mount to vertical CIM wall channel (compatible with GCX channel)	0.1 kg / 0.2 lbs	4Z
	Universal pole clamp	V-block to mount to poles ø 23 - 40 mm / ø 0.9 - 1.6"	0.6 kg / 1.3 lbs	1V
	Fixed pole clamp	To mount to pole ø 25 mm / ø 1" To mount to pole ø 30 mm / ø 1.2" To mount to pole ø 35 mm / ø 1.4" To mount to pole ø 38 mm / ø 1.5"	0.3 kg / 0.7 lbs 0.4 kg / 0.9 lbs 0.4 kg / 0.9 lbs 0.4 kg / 0.9 lbs	1 1B 1F 1C

## Wall channel and European rail



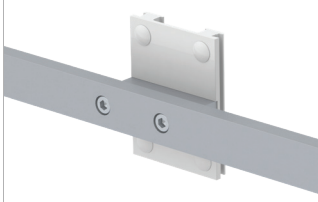

Illustration	Description	Length	Weight	Part no.
	<p><b>CIM wall channel</b></p> <p>Vertical wall channel including channel cover and end caps</p> <p>Individual lengths on request!</p> <p>Channel cover available in two colours (C): RAL 7024 graphite grey (gr) or RAL 9016 traffic white (w)</p>	<p>480 mm / 18.9"</p> <p>720 mm / 28.3"</p> <p>960 mm / 37.8"</p> <p>1200 mm / 47.2"</p>	<p>0.9 kg / 2.0 lbs</p> <p>1.3 kg / 2.9 lbs</p> <p>1.7 kg / 3.7 lbs</p> <p>2.1 kg / 4.6 lbs</p>	<p>Z-WK.C_480</p> <p>Z-WK.C_720</p> <p>Z-WK.C_960</p> <p>Z-WK.C_1200</p>
	<p><b>European rail 10 x 25 mm</b></p> <p>To mount to CIM wall channel including adapter for vertical wall channel</p>	<p>300 mm / 11.8"</p> <p>400 mm / 15.7"</p> <p>500 mm / 19.7"</p>	<p>0.4 kg / 0.9 lbs</p> <p>0.5 kg / 1.1 lbs</p> <p>0.5 kg / 1.1 lbs</p>	<p>Z-NS-4Z.1_300</p> <p>Z-NS-4Z.1_400</p> <p>Z-NS-4Z.1_500</p>



# Keyboard tray



Illustration	Description	Length (T)	Weight	Part no.
	<b>Keyboard tray magnetic with fold-up function</b> max. load capacity: 5 kg / 11 lbs	30S: 300 x 210 mm / 11.8 x 8.3" 40S: 400 x 150 mm / 15.8 x 5.9" 50S: 500 x 200 mm / 19.7 x 7.9" 58S: 580 x 200 mm / 22.8 x 7.9" 65S: 650 x 200 mm / 25.6 x 7.9"	2.4 kg / 5.3 lbs 2.5 kg / 5.5 lbs 2.9 kg / 6.4 lbs 3.1 kg / 6.8 lbs 3.3 kg / 7.3 lbs	Z-EF-Y.CD_T
	<b>Keyboard tray with fold-up function and left/ right retractable mouse tray</b> max. load capacity: 5 kg / 11 lbs	RC: 480 x 220 mm / 18.9 x 8.7"	3.5 kg / 7.7 lbs	Z-EF-Y.CD_T
	<b>Keyboard tray magnetic retractable and with fold-up function</b> max. load capacity: 5 kg / 11 lbs	50S: 500 x 200 mm / 19.7 x 7.9" 58S: 580 x 200 mm / 22.8 x 7.9"	3.1 kg / 6.8 lbs 3.3 kg / 7.3 lbs	Z-ER-Y.CD_T

## Colours to choose

Decorative parts (C)

gr = RAL 7024 (graphite grey)

bl = RAL 5013 (cobalt blue)

Aluminium parts (D)

1 = RAL 9016 (traffic white)

2 = RAL 9002 (grey white)

## Fixings Y

details page 26



5

Horizontal rail clamp



3

Vertical rail clamp



4S

Adapter for vertical wall channel



1V

Universal pole clamp



1

1B

1F





1C

Fixed pole clamp

# Fixings Y

## for keyboard trays



Illustration	Description	Notes	Weight	Part no.
	Horizontal rail clamp	To mount to horizontal European rail 10 x 25, 8 x 35, 10 x 30 mm	0.4 kg / 0.9 lbs	5
	Vertical rail clamp	To mount to vertical European rail 10 x 25 mm	0.5 kg / 1.1 lbs	3
	Adapter for vertical wall channel	To mount to CIM wall channel (compatible with GCX channel)	0.6 kg / 1.3 lbs	4S
	Universal pole clamp	V-block to mount to poles ø 23 - 40 mm / ø 0.9 - 1.6"	0.6 kg / 1.3 lbs	1V
	Fixed pole clamp	To mount to pole ø 25 mm / ø 1" To mount to pole ø 30 mm / ø 1.2" To mount to pole ø 35 mm / ø 1.4" To mount to pole ø 38 mm / ø 1.5"	0.3 kg / 0.7 lbs 0.4 kg / 0.9 lbs 0.4 kg / 0.9 lbs 0.4 kg / 0.9 lbs	1 1B 1F 1C

# Handle



Illustration	Description	Notes	Weight	Part no.
	<b>Dual handle with VESA fixing</b>	For monitors with a maximum width of 430 mm / 16.9"	1.5 kg / 3.3 lbs	Z-HDG.1_43
		570 mm / 22.4"	1.9 kg / 4.2 lbs	Z-HDG.1_57

Example of use Z-HDG.1



	<b>Handle for carts</b>	Colours to choose (C): RAL 5013 cobalt blue (bl) or RAL 7024 graphite grey (gr) or RAL 9016 traffic white (w)	0.8 kg/ 1.8 lbs	Z-HD-4.C1
---	-------------------------	--	-----------------	-----------

Example of use Z-HD-4.gr1



# Handle

Illustration	Description	Notes	Weight	Part no.
	<b>Handle for monitor mount VESA</b>	Colours to choose (C): RAL 7024 graphite grey (gr) or RAL 5013 cobalt blue (bl)  Colour of the aluminium parts (D): RAL 9016 traffic white (1) or RAL 9002 greywhite (2)	1 kg / 2.2 lbs	Z-HD-G.CD

Example of use Z-HD-G.gr1



	<b>Handle for 5" plunge plate, Mindray and Philips</b>	Colours to choose (C): RAL 7024 graphite grey (gr) or RAL 5013 cobalt blue (bl)	0.5 kg / 1.1 lbs	Z-HDR-HZ.C
---	--	---	------------------	------------

Example of use Z-HDR-HZ

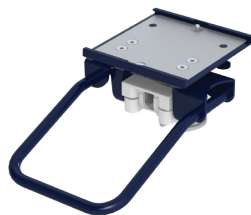

5" Plunge Plate



Philips Table Top Mount



Mindray Mounting Adapter

## Down post



Illustration	Description	Notes	Weight	Part no.
	<b>Down post, rotatable</b>	For non-height adjustable arms:		
		L 150 mm / 5.9", max. load 12 kg / 26.5 lbs	0.2 kg / 0.4 lbs	Z-DPR-70.CD_150
		L 300 mm / 11.8", max. load 10 kg / 22 lbs	0.3 kg / 0.7 lbs	Z-DPR-70.CD_300
		For height adjustable arms:		
		L 150 mm / 5.9", max. load 12 kg / 26.5 lbs	0.2 kg / 0.4 lbs	Z-DPR-71.CD_150
		L 300 mm / 11.8", max. load 10 kg / 22 lbs	0.3 kg / 0.7 lbs	Z-DPR-71.CD_300

### Colours to choose







#### Decorative parts (C)

gr = RAL 7024 (graphite grey)  
 bl = RAL 5013 (cobalt blue)

#### Aluminium parts (D)

1 = RAL 9016 (traffic white)  
 2 = RAL 9002 (grey white)

## Miscellaneous

Illustration	Description	Notes	Weight	Part no.	
	<b>Bottle holder</b>	Incl. adapter to mount to CIM wall channel (compatible with GCX channel) Please order CIM wall channel separately Max. bottle diameter: 140 mm / 5.5" Maximum weight: 25 kg / 55.1 lbs (6-fold safety)	1.1 kg / 2.4 lbs	Z-GFH-4.1	
	<b>Mounting solution for barcode scanner</b>	For Z-bracket right hand side, when the holder is ordered together with the support arm  For Z-bracket right hand side	0.4 kg / 0.9 lbs  0.4 kg / 0.9 lbs	0-BCS-Mr.1  Z-BCS-Mr.CD	<del></del>
	<b>Mounting solution for barcode scanner</b>	Fixing details page 31	0.2 kg / 0.4 lbs	Z-BCS-Y.1	<del></del>
	<b>Mounting solution for barcode scanner for CIM keyboard tray</b>	Can be mounted left and right side of keyboard trays with non-retractable mouse trays	0.3 kg / 0.7 lbs	Z-BCS-TAB.1	<del></del>

# Fixings Y

## for holder barcode scanner

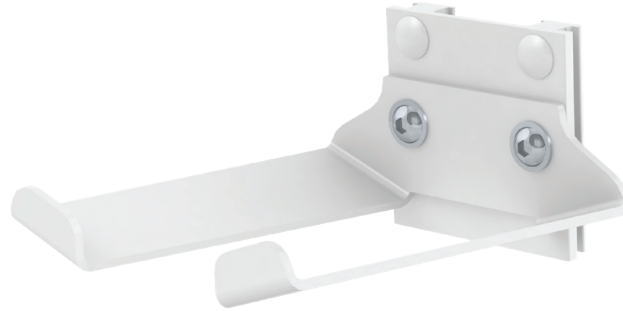





Illustration	Description	Notes	Weight	Part no.
	Horizontal rail clamp	To mount to horizontal rail 10 x 25, 8 x 35, 10 x 30, 10 x 50 mm	0.2 kg / 0.4 lbs	6H
	Vertical rail clamp	To mount to vertical rail 10 x 25, 8 x 35, 10 x 30, 10 x 50 mm	0.2 kg / 0.4 lbs	6V
	Adapter for vertical wall channel	To mount to vertical CIM wall channel (compatible with GCX channel)	0.1 kg / 0.2 lbs	4Z
	Fixed pole clamp	To mount to pole $\varnothing$ 25 mm / $\varnothing$ 1"	0.6 kg / 1.3 lbs	1



**CIM med GmbH**

Euro-Industriepark  
Margot-Kalinke-Str. 9  
80939 Munich / Germany

T +49 89. 978 94 08-0

---

**CIM med Inc.**

2024 E Independence Commerce Dr  
Matthews, NC 28105 / USA

T +1 855 895 4722

---

[info@cim-med.com](mailto:info@cim-med.com)

[www.cim-med.com](http://www.cim-med.com)

